

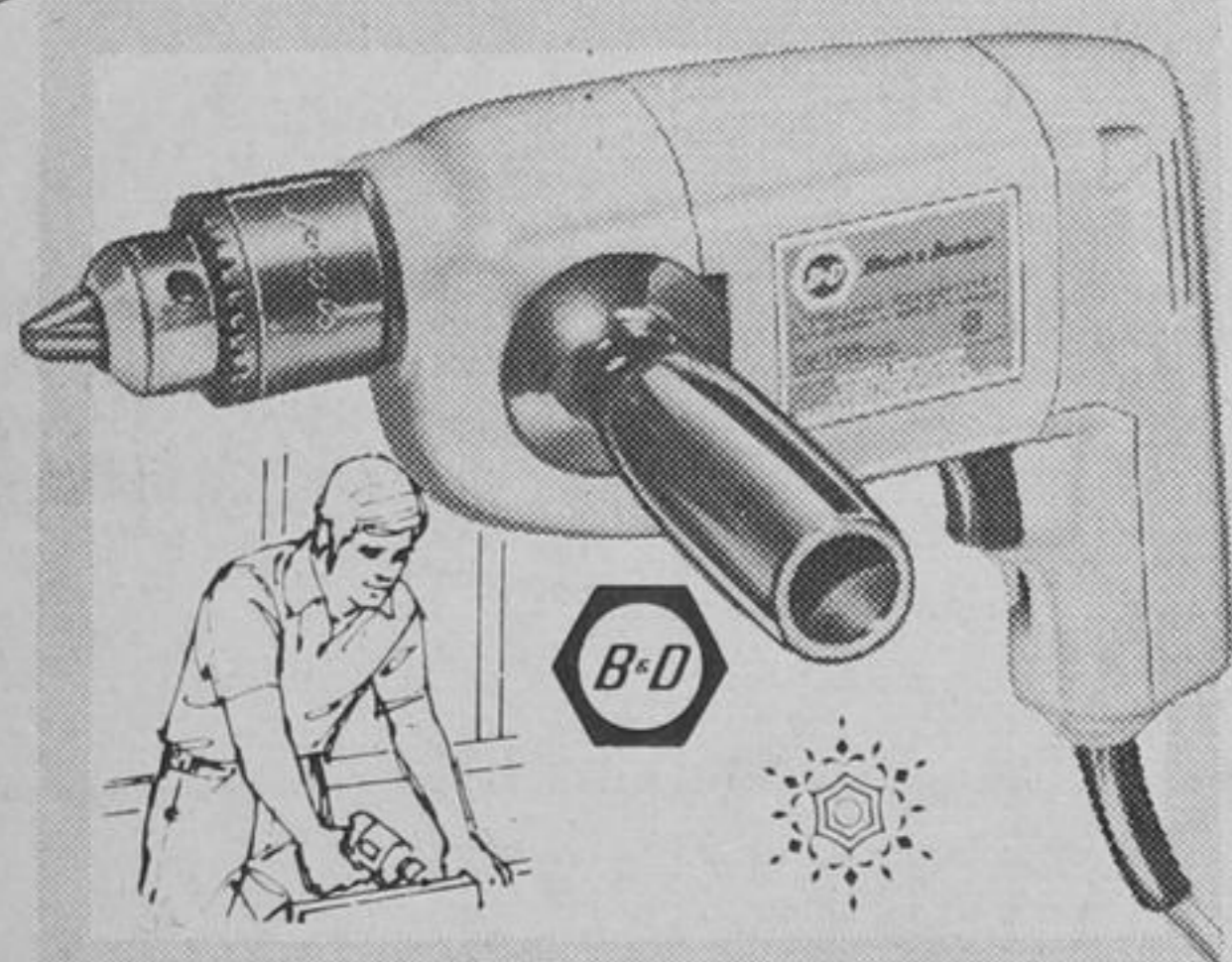

# HOME for

## From Santa's Shop To Yours...



BLACK AND DECKER BUILDS IT BETTER  
**1/2" Double-Insulated Drill**

Special Purchase **31<sup>95</sup>**

Powerfully tackles solid brick, ferrous & non-ferrous metals, hardwood. Locking trigger. Detachable side handle. 550 rpm. 3 amp. 99-2547

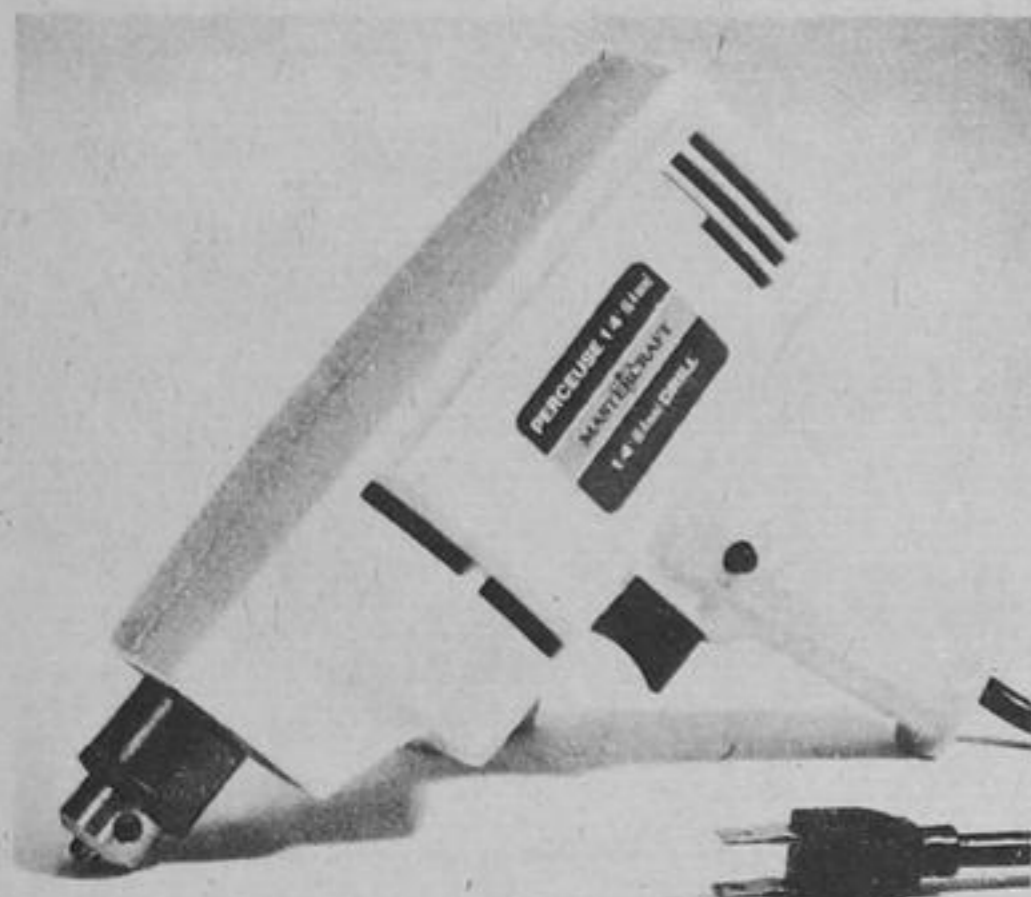

54-2806

**Single-Speed 1/4" Drill**  
2.2 AMP Motor. No load speed 2400 RPM

SAVE \$4<sup>00</sup> **\$9<sup>95</sup>**  
Reg. \$13<sup>95</sup>

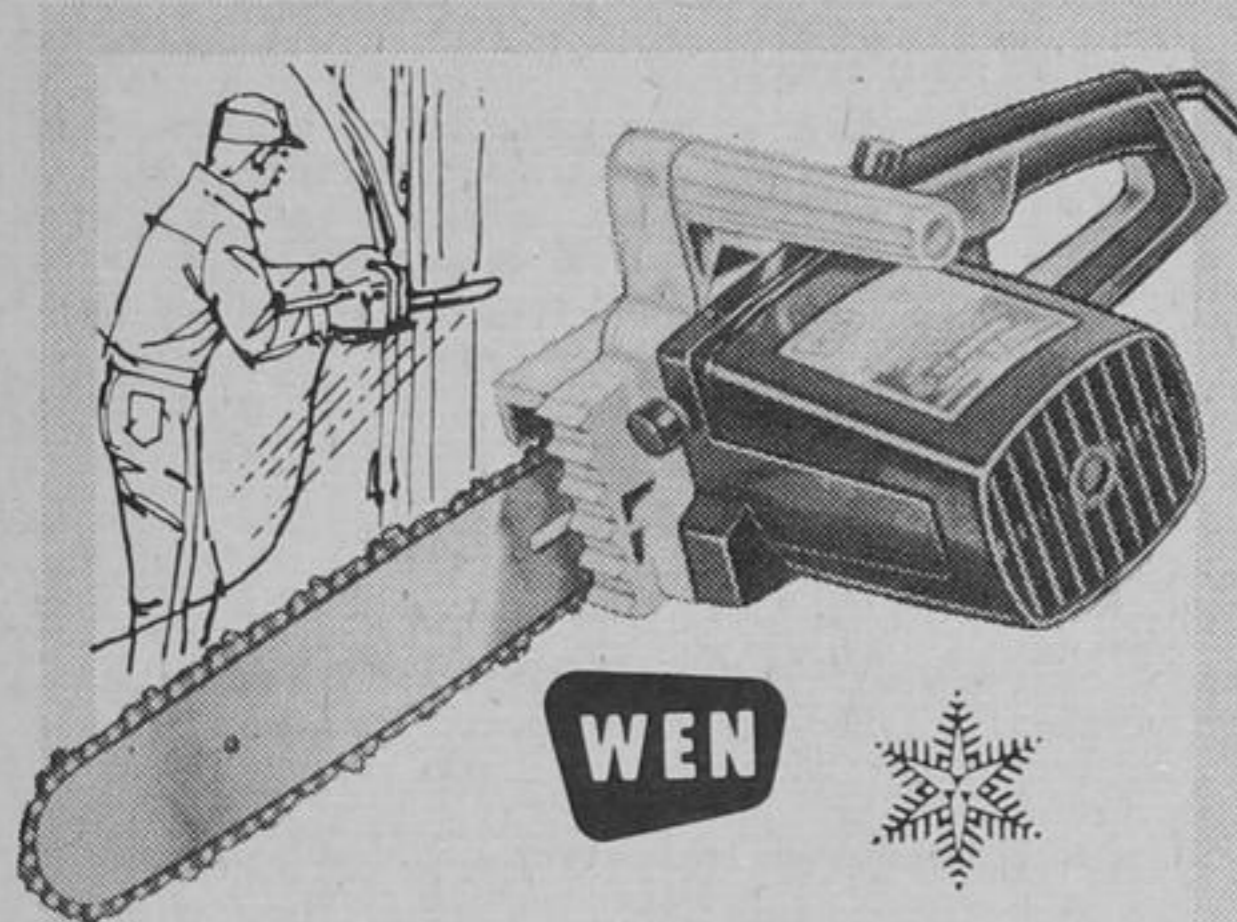

CUTS IT IN THE BACKYARD OR BACKWOODS  
**WEN 10" Electric Chain Saw**

Plugs into any 120 V outlet **48<sup>95</sup>**

Unitized 11-amp motor. 20" cutting capacity. 5000 rpm no-load sprocket speed. Anti-kickback clutch. Double-insulated housing. 58-5637

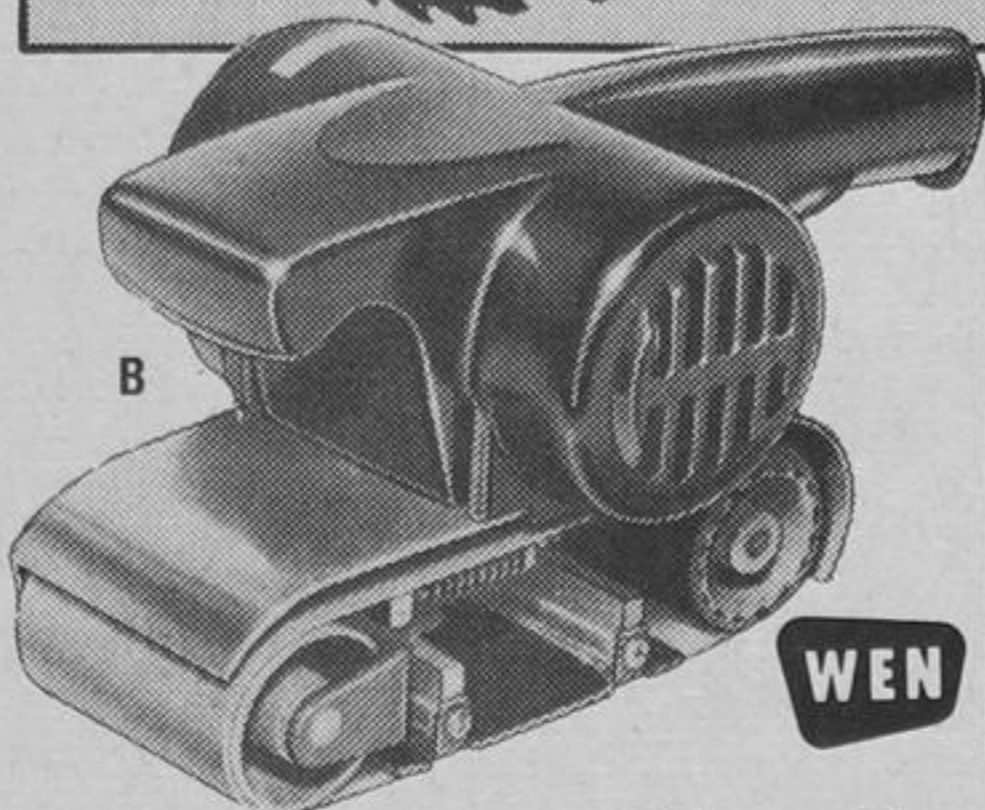
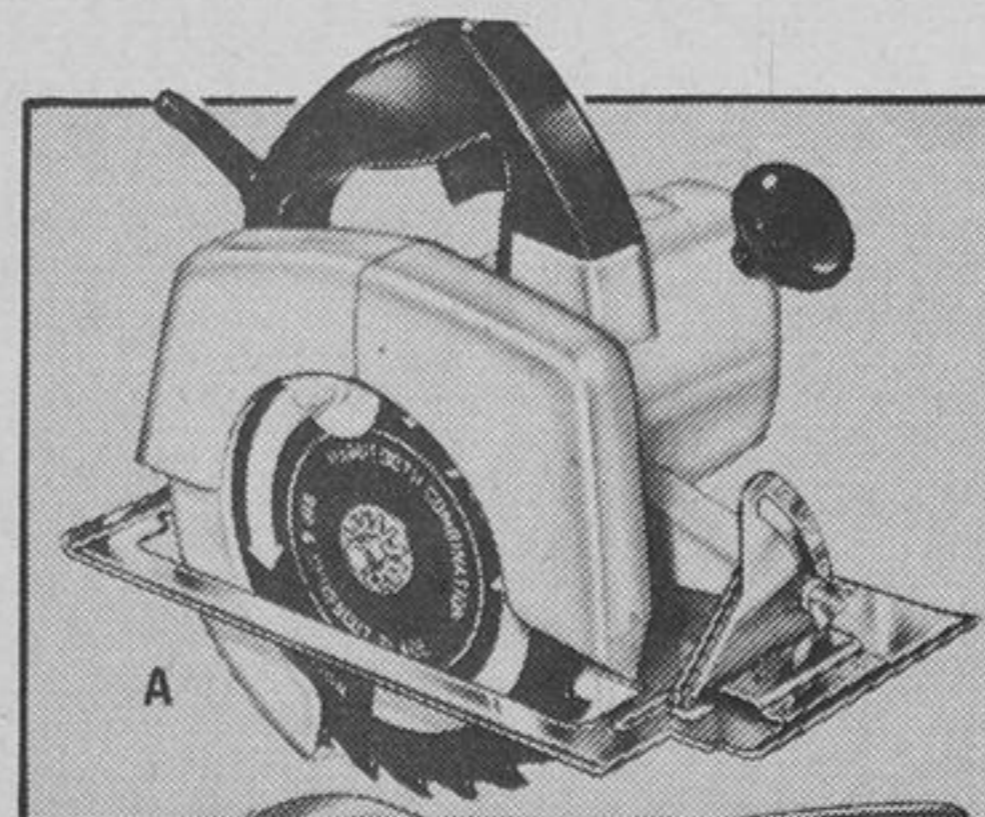

**7 1/4" Circular Saw**

A. **Mastercraft**. Double insulated 8-amp motor at 4500 rpm; life-lubed bearings; steel cut helical gears; cuts to 2-7/16" at 90°; 1-15/16" at 45°. 115V. **26<sup>99</sup>**

**WEN 3" Belt Sander**

B. Powerful, burn-out protected 4-amp motor drives 3 x 18" belt at 1000 spm. Heavy-duty gears. Fine, medium, coarse sanding belts included. **58<sup>95</sup>**

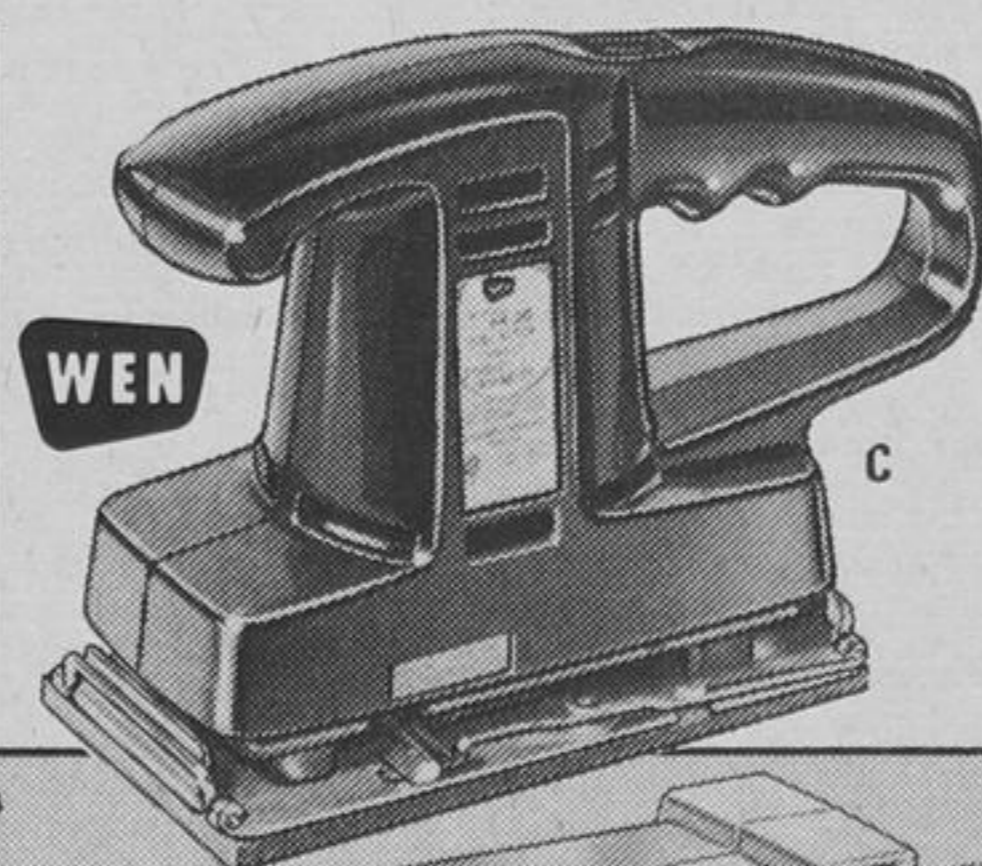

**Dual-Action Sander**

C. **Wen** quality. Safety double-insulated 2.6-amp motor. Orbital or straight sanding at 4000 spm. Non-slip lever clamps hold 9 x 3 3/8" sandpaper. **35<sup>95</sup>**

**Mastercraft Grinder**

D. 8-amp at 3450 rpm, will grind, buff, polish or wire-brush the hardest materials. Fine- and coarse-grit 6 x 1/2 x 1/2" grinding wheels. Workshop value. **66<sup>95</sup>**

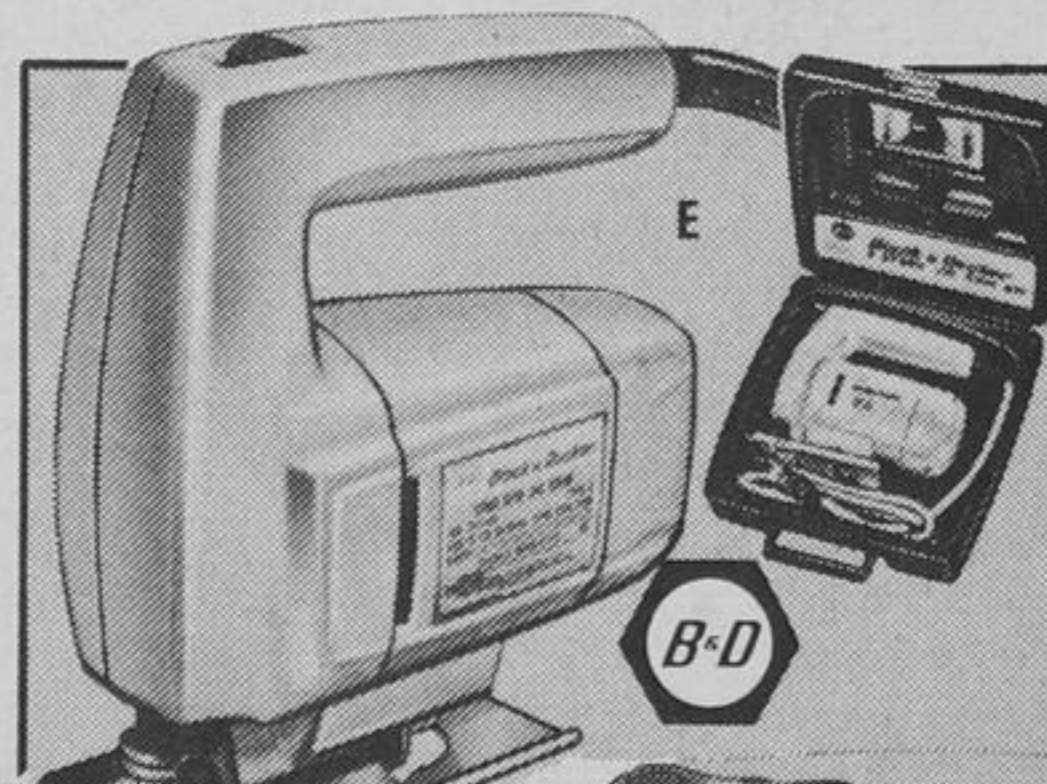

**2-Speed Jig Saw Kit**

E. Reliable **Black and Decker** #7519-04 kit includes double-insulated saw, rip fence, 4 assorted blades and fitted carry case. **\$25<sup>95</sup>**  
Power economy buy . . . . .

**B & D Routing Kit**

F. **Black and Decker** #7611 kit includes 3/4-hp, 22,000 rpm router; 1/64" calibration; cutting guide; 1/4" HSS straight 2-flute bit, wrenches and case. **61<sup>95</sup>**

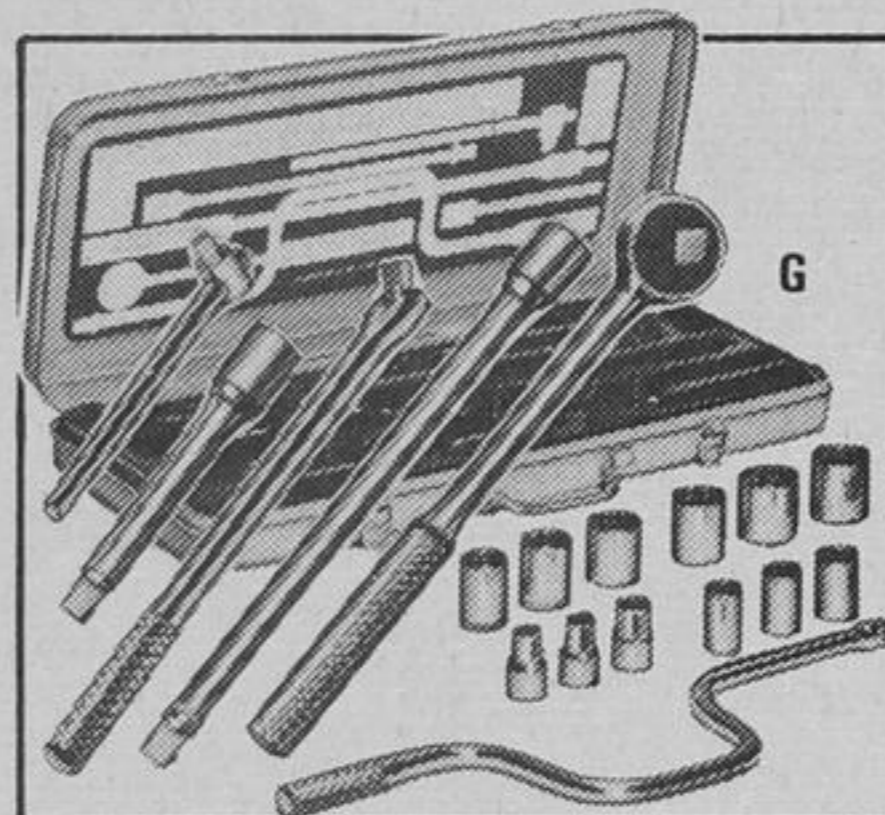

**19-PIECE 1/2-INCH DRIVE SET**  
G. Twelve 12-point sockets in SAE sizes. **Mastercraft**. **35<sup>95</sup>**

**EVANS POWER-LOCK TAPE**  
H. 12-ft x 3/4" Mylar-coated blade. Tough chromed case. **77<sup>9</sup>**

**1-LB BALL PEIN HAMMER**  
J. Selected steel head; 14 1/2" straight-grain hickory grip. **59<sup>9</sup>**

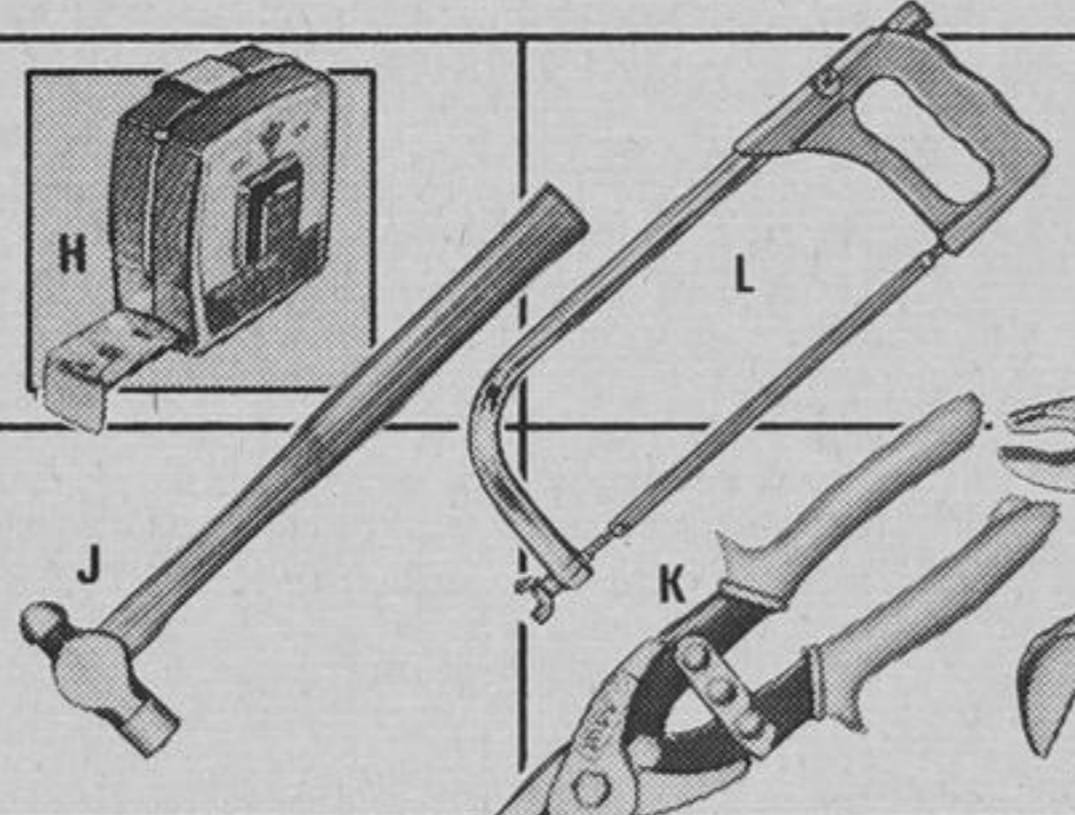

**WISS AVIATION TYPE SNIPS**  
K. Compound-action; plastic-sheathed grip. 10 x 2 1/4" cut. **64<sup>9</sup>**

**TUBULAR STEEL FRAME HACKSAW**  
L. Uses 10 or 12-inch blades. Complete with 10-inch blade. **84<sup>9</sup>**

**10-INCH WATER PUMP PLIERS**  
M. **Mastercraft** quality. High-grade steel. Chrome finish. **44<sup>9</sup>**

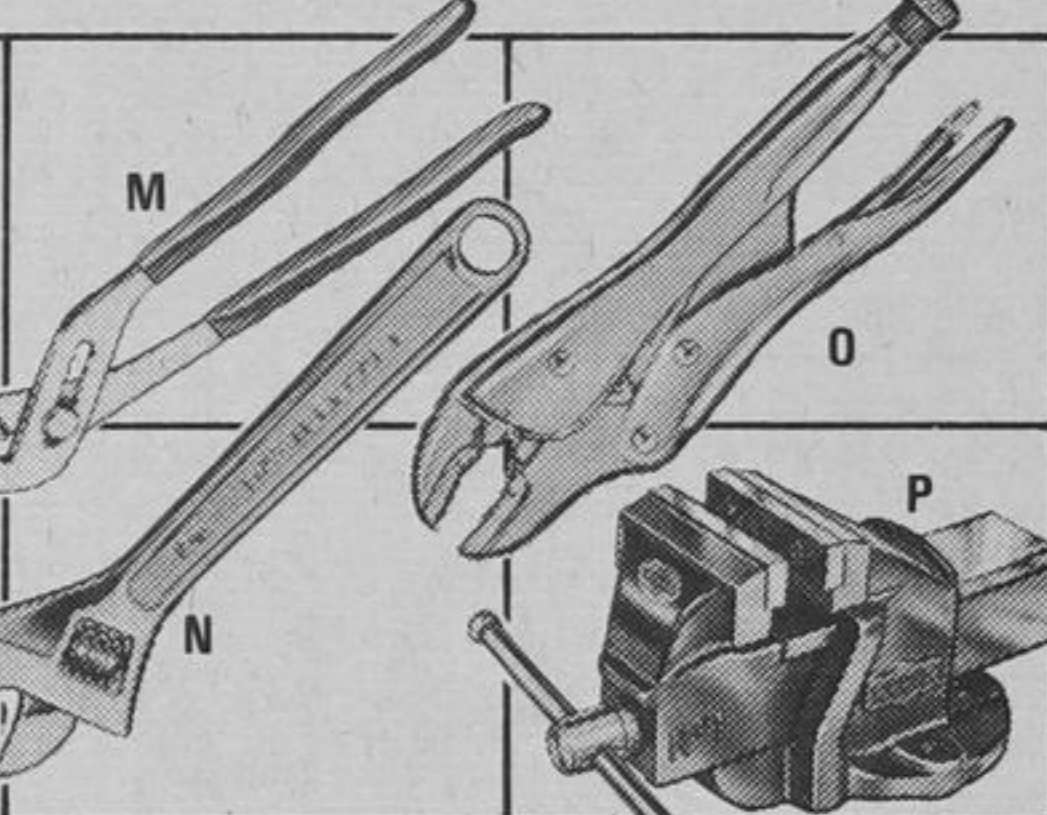

**MASTERCRAFT ANGLE WRENCH**  
N. Rugged chromed steel. 12" size (jaws open to 1 1/8"). **89<sup>9</sup>**

**MULTI-PURPOSE LOCK WRENCH**  
O. Strong steel, construction. 10" size (jaws open 1 3/4"). **49<sup>9</sup>**

**WODEN MECHANIC'S VICE**  
P. Great leverage and grip, 4 to 4 3/4" open jaws. **42<sup>99</sup>**

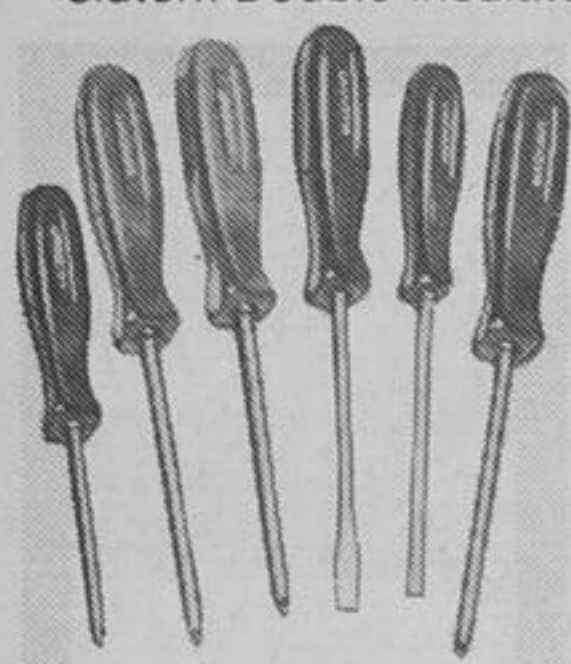

**Mastercraft Screwdrivers**  
6-piece set

**6<sup>99</sup>**

2 each; Slot, Phillips, Robertson-types. Hi-quality buy. 57-3513

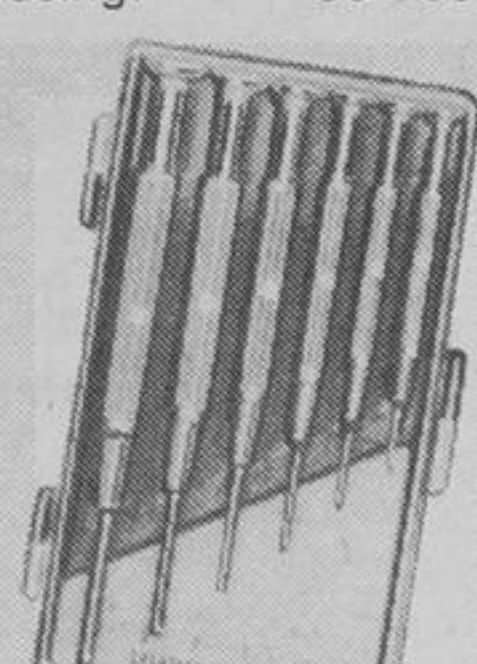

**Precision Screwdrivers**  
6-piece set

**2<sup>99</sup>**

1/32 to 9/64" blades and durable plastic case. Value. 57-3511



**Mastercraft Power Tape**  
16-ft x 3/4" blade

**9<sup>59</sup>**

Yellow tape has easy-to-read red numerals. Auto-return. 57-7060

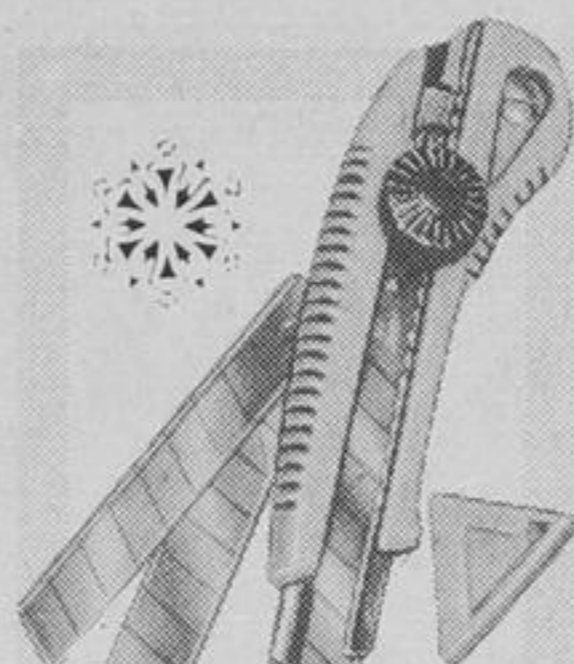

**Heavy-Duty Utility Knife**  
Includes 2 blades

**2<sup>99</sup>**

Pistol-grip; ratchet-type lock. Has blade snapper. 57-5048

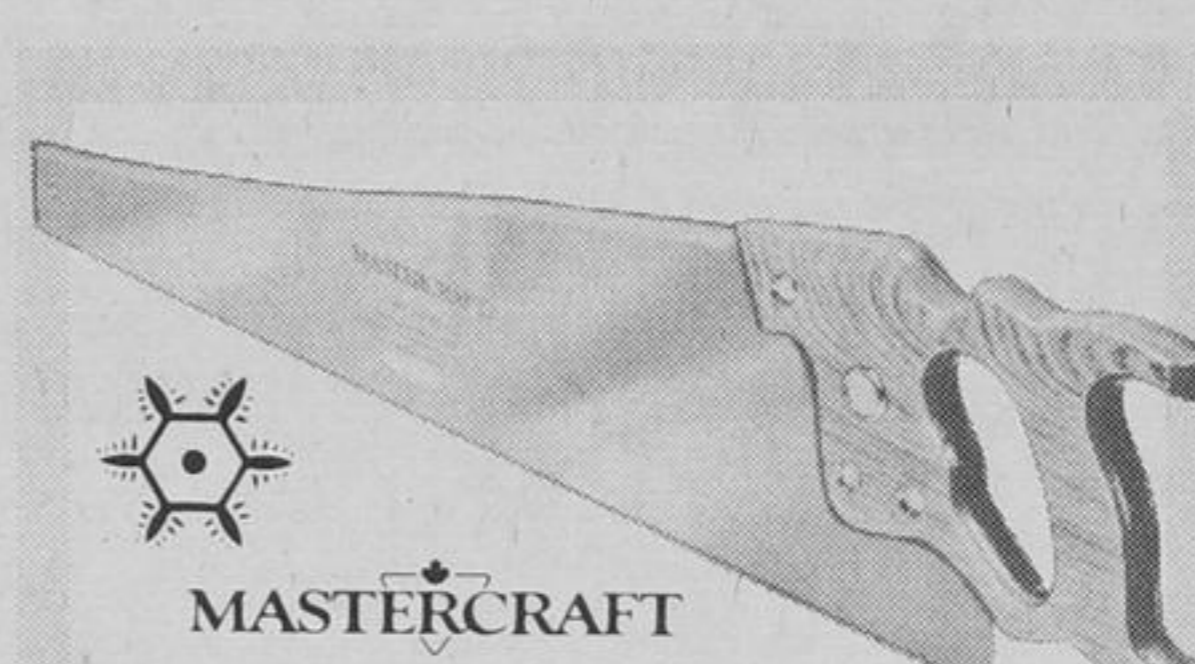

GIFT VALUE MAKES WOODWORK EASIER  
**Mastercraft 8-Point Saw**

Long-Lasting 26" alloy-steel blade **11<sup>99</sup>**

Quality crosscut handsaw for carpenters or home handymen. Features hand-set, bevel-filled teeth and comfort grip hardwood handle. 57-7454



**Deluxe 9" Smooth Plane**  
2" tool-steel cutter

**15<sup>49</sup>**

Precise lateral and depth cutting adjustments. Value. 57-6245

**EXTRA SAVINGS CASH BONUS COUPONS USE YOUR CANADIAN TIRE CREDIT CARD**  
OPEN 9 AM - 9 PM MON.-FRI. SAT. 9AM-6PM