



CANADIAN TIRE

9.90
PAIR
Regular \$11.98

Save \$2.08

MOTO-MASTER RIDE-A-MATIC Shock Absorbers

For most popular makes, models. Built-in controls provide a cushioned ride at low speeds, stability at high speeds. Guaranteed for as long as you own the car on which they are originally installed. (Ask your local dealer for details.)

PAIR **9.90**

Save 20%

FRONT END SPECIAL

Parts* and Installation

*UPPER and LOWER BALL JOINTS — and TIE-ROD ENDS as stocked by your Canadian Tire Store

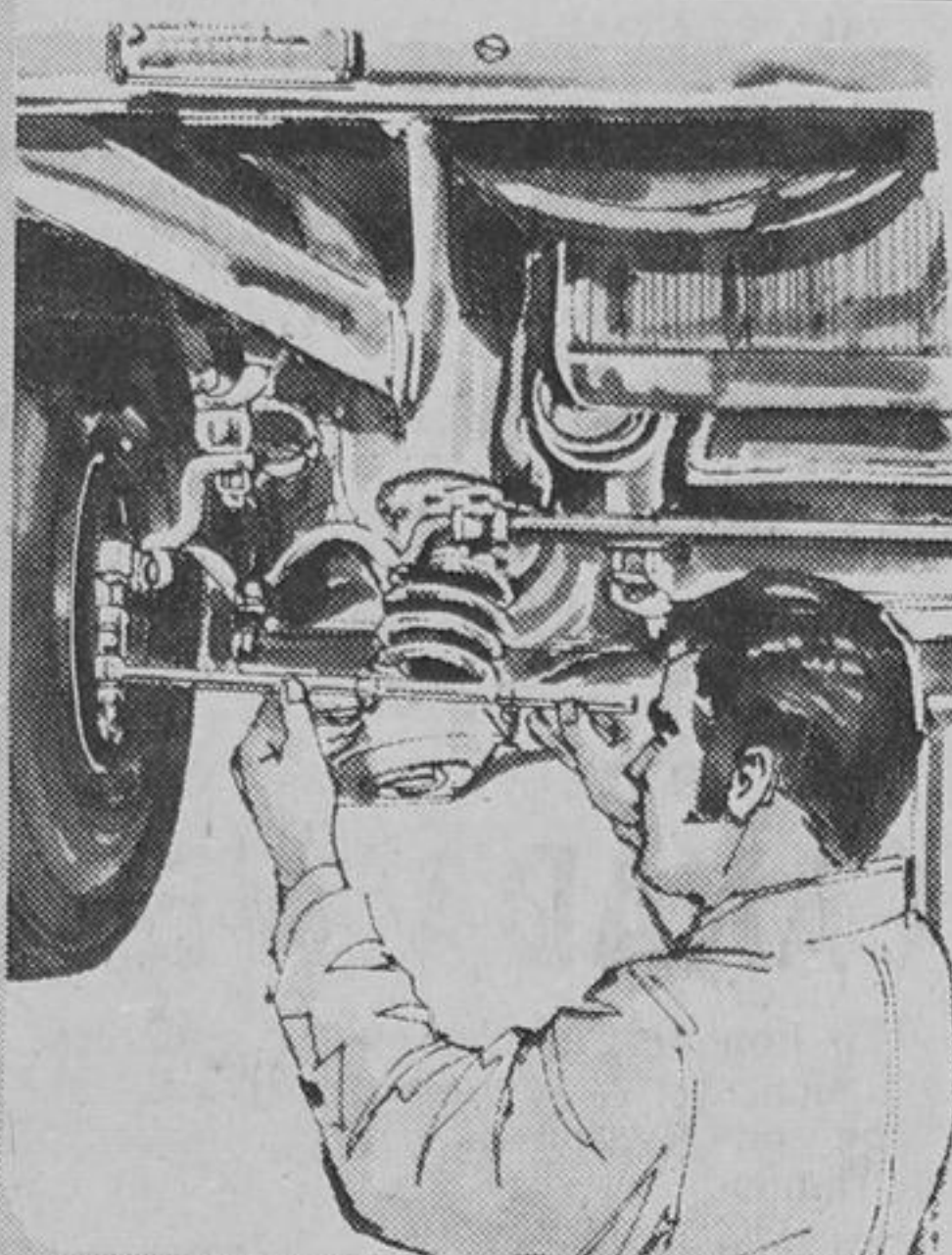

Save 20%

UPPER and LOWER BALL JOINTS

Sample Savings: Chevrolet and Pontiac 1958-72 (full size)

UPPER Ball Joints
Reg. \$7.49-7.99 Each
Over-the-counter **5.99** to \$6.39

LOWER Ball Joints
Reg. \$8.95-\$10.95 Each
Over-the-counter **7.18** to \$8.76

TIE-ROD ENDS

1965-70
Reg. \$4.49
to \$5.49

3.59 to **4.39** EACH

1971-73
Regular \$10.89

8.71 EACH

Similar Savings for most Canadian and American cars.

Save 20% Wheel Alignment

Whether you choose to take advantage of our regular wheel alignment or our complete 11 step wheel alignment including steering and suspension check... you will save a big 20% if you make your appointment before June 22nd.

(Parts and installation extra, if required.)

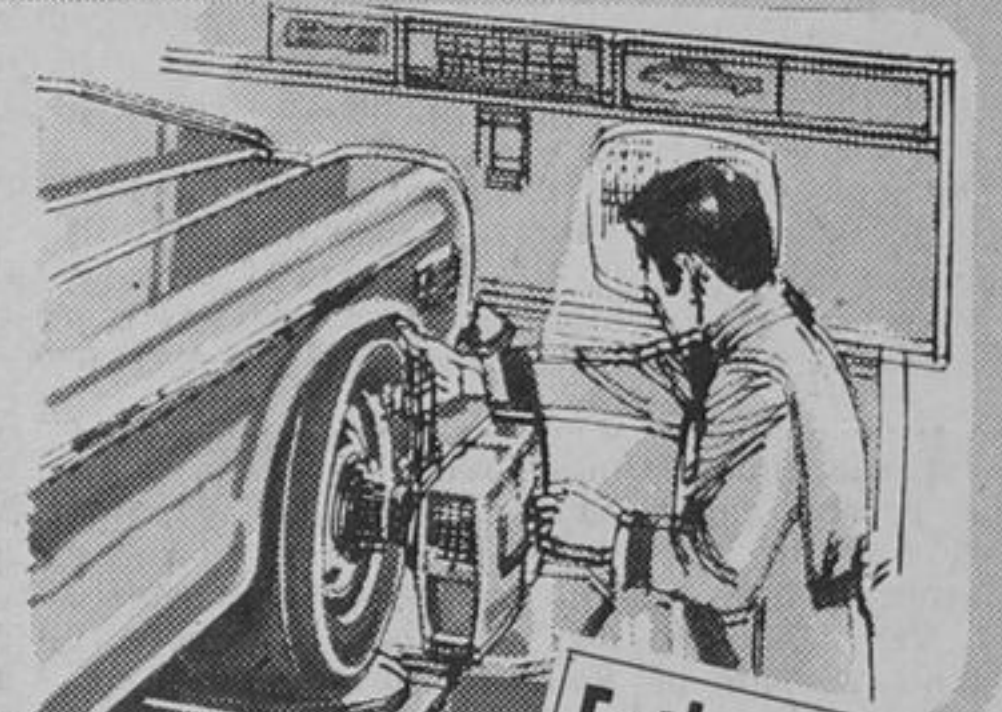

BRAKES

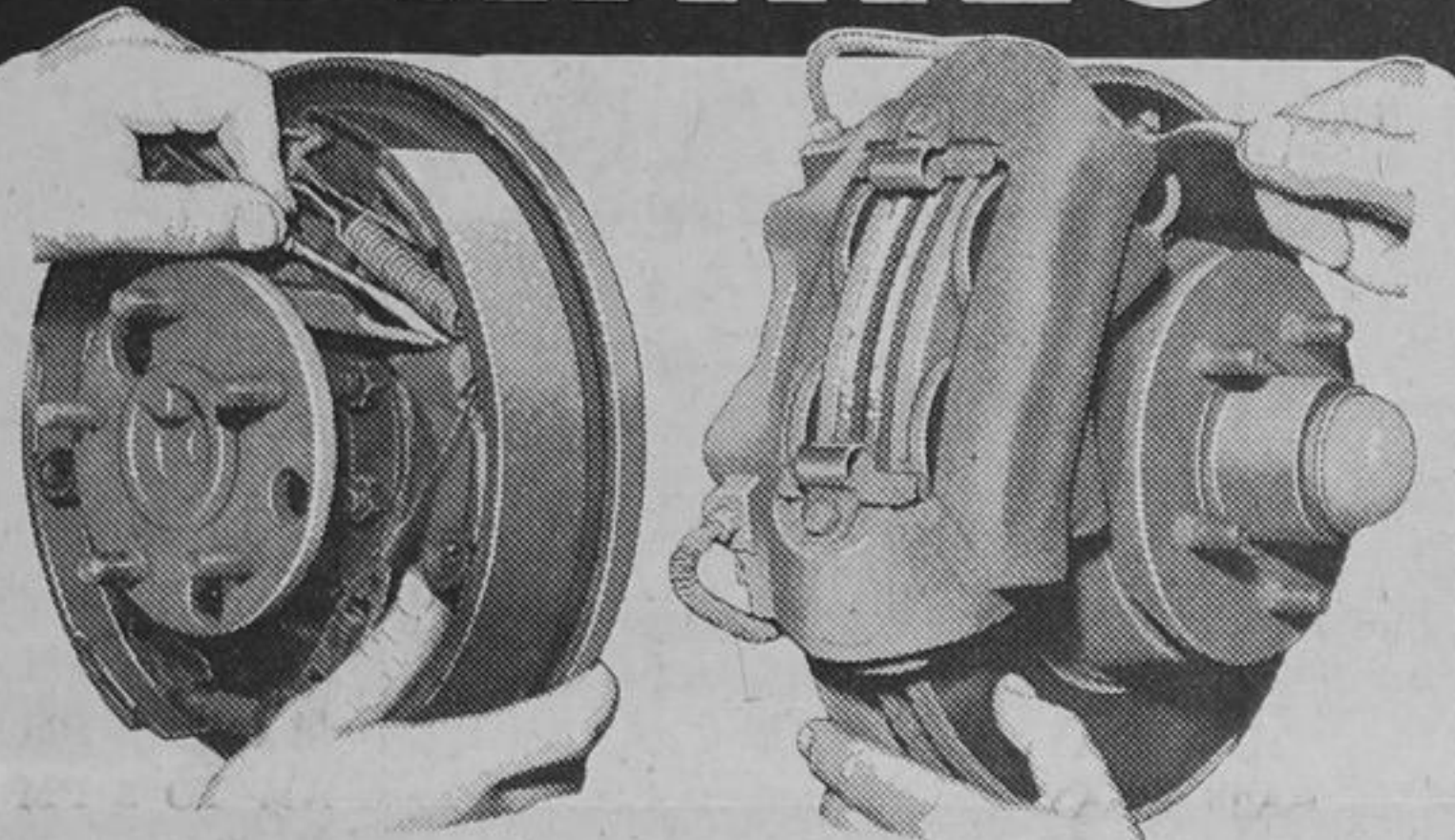

For popular car-makes equipped with

For popular car-makes equipped with

BRAKE SHOES

Example: 1959-70 Chev. and Pontiac (full-size)

FRONT WHEELS **6.99** Exch.
Custom Bonded Linings

REAR WHEELS **5.99** Exch.
Custom Bonded Linings

DISC BRAKES

Example: 1968-72 Ford, Mercury, Meteor (full-size)

FRONT WHEELS **13.59** Exch.
Rivited Disc Pads

REAR WHEELS **7.35** Exch.
Custom Bonded Linings

Moto-Master brake linings are designed and engineered for heavy-duty city or expressway travel. Ask your dealer about similar low prices on other hydraulic brake parts. 12,000 miles or 12 months (whichever occurs first) guarantee. Ask also about the generous parts-and-service guarantee on every complete brake system overhaul.

Similar low prices for other makes

INSTALLATION SPECIAL - ONE WEEK ONLY!

DRUM BRAKES (front & rear) **\$18**

DISC BRAKES (front only) **\$14**

ALL CANADIAN BUILT CARS
ALL CARS

Gifts for Dad's Big Day

Father's Day
SUNDAY
JUNE 16th

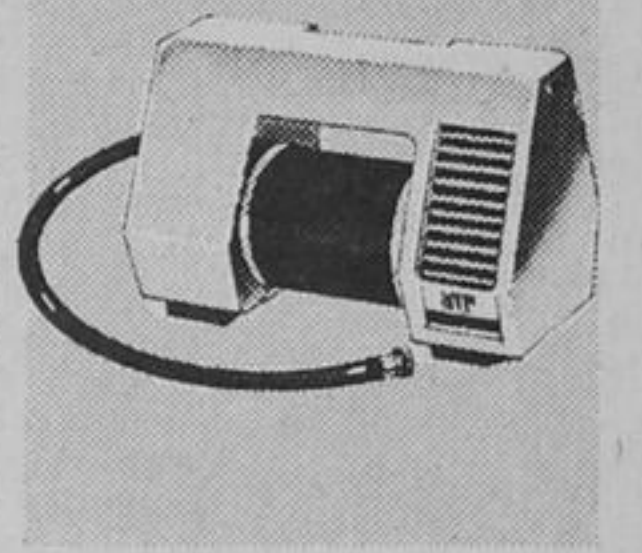
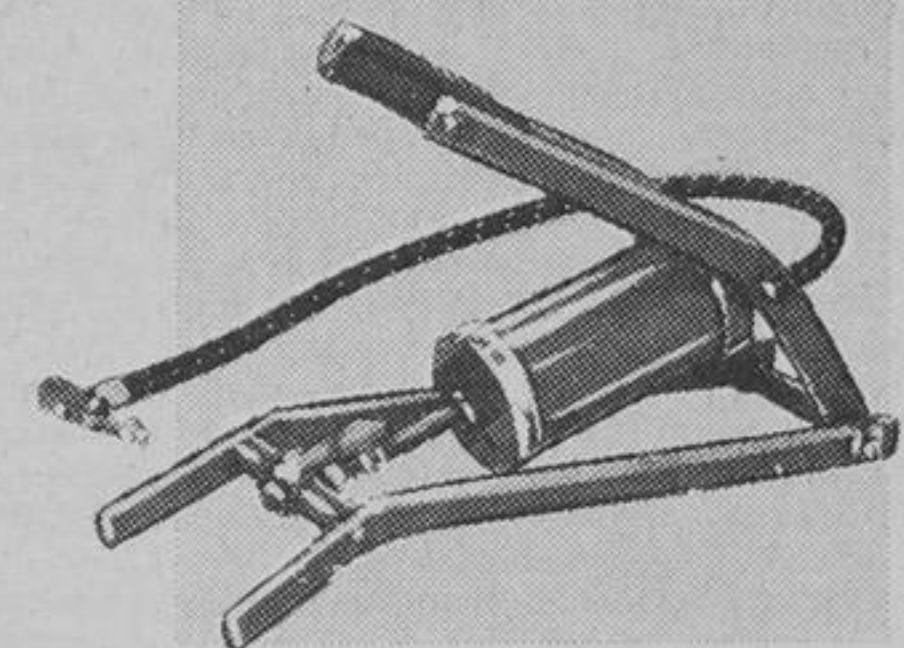
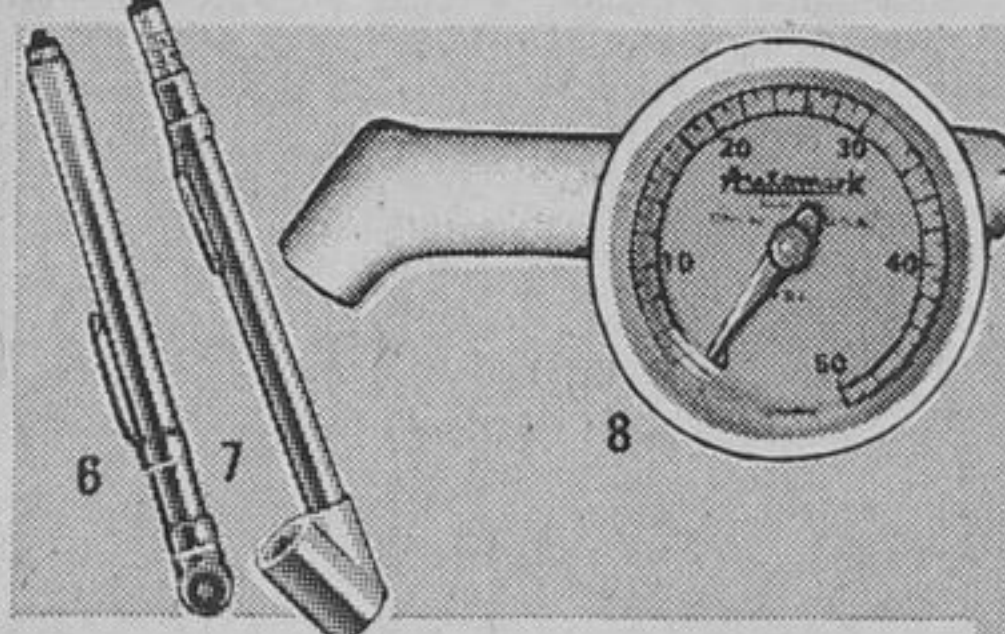
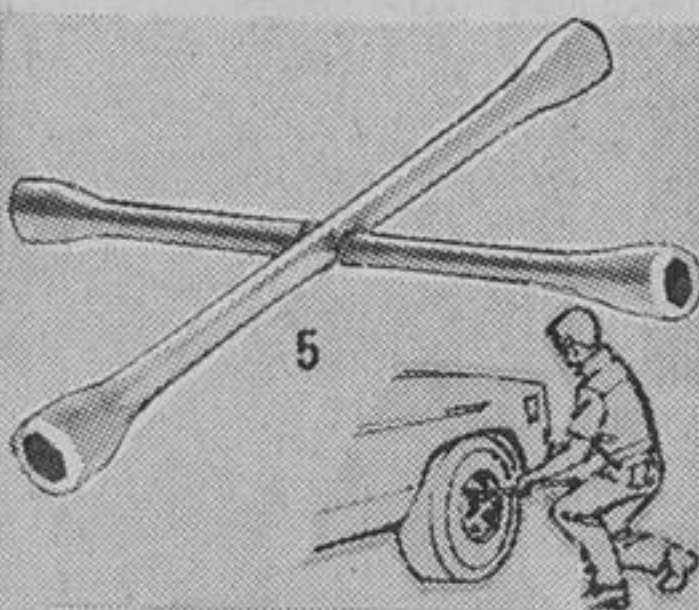

Get A Gauge on the Pressure

5. WHEEL WRENCH **1.79**
14 1/2" overall.
20", \$3.39; Metric, \$1.95; British, \$2.29

6. HIGH PRESSURE GAUGE **1.69**
Registers 10 to 120 pounds.

'LOW' GAUGE **1.45**
6 to 50 pounds

7. SERVICE PRESSURE GAUGE **3.19**
Reaches most tire valves. Pocket clip, 10-120 lbs.

8. DIAL-TYPE TIRE GAUGE **1.89**
Accurate, easy to read. Unbreakable case. 0-50 lb.

COMPACT SPEED Foot Pump

Pump up a tire or air mattress quickly by foot, avoid backache. **5.99**
Efficient unit.

NEW 12-VOLT Tire Pump Kit

Compressor/pump gives up to 45 p.s.i. Connect to lighter. Hose, adapters. **29.89**

MUFFLERS



THREE GREAT GUARANTEED MUFFLERS

Example: Most '65-'68 Chev. & Pontiac (Canadian) 283 and 307 V-8

| STANDARD | HEAVY DUTY | SUPREME |
|---------------------------------------|---|-----------------------------------|
| Guaranteed 18 MONTHS | Guaranteed 25 MONTHS | Guaranteed 30 MONTHS |
| 6.85 Plus installation | 8.79 Plus installation | 10.29 Plus installation |
| Quality Constructed cold rolled steel | Heavy-gauge cold rolled steel all through | Coated steel outer shell and caps |

Moto-Master Mufflers are quality constructed to give protection against deadly exhaust fumes. Each has specially-designed inner components and sound chambers to minimize power-robbing back pressure.

Check our low prices on other makes

INSTALLATION just \$5 (most popular cars)

Down to the Nuts and Bolts

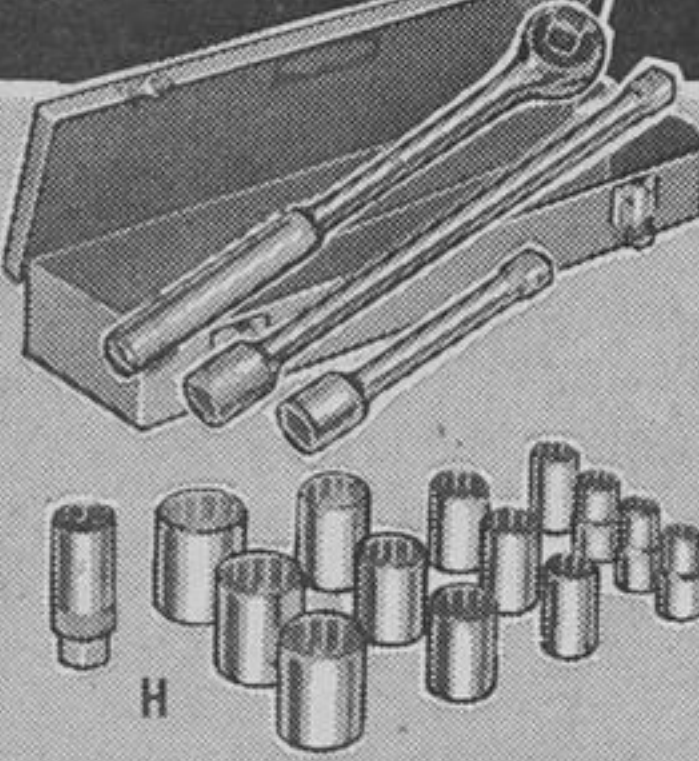

H. 18-PIECE 1/2" SQUARE-DRIVE SET **36.95**
Includes thirteen 12 point sockets; six-point spark plug socket; 5", 10" extensions; reversible ratchet. Strong divided metal box.

J. 21-PIECE 1/2" SQUARE-DRIVE SET **52.95**
Three 6-point sockets; ten 12 point; spark plug socket; 5", 10" extensions; 18" flex handle; reversible ratchet; universal joint; 19" speeder.

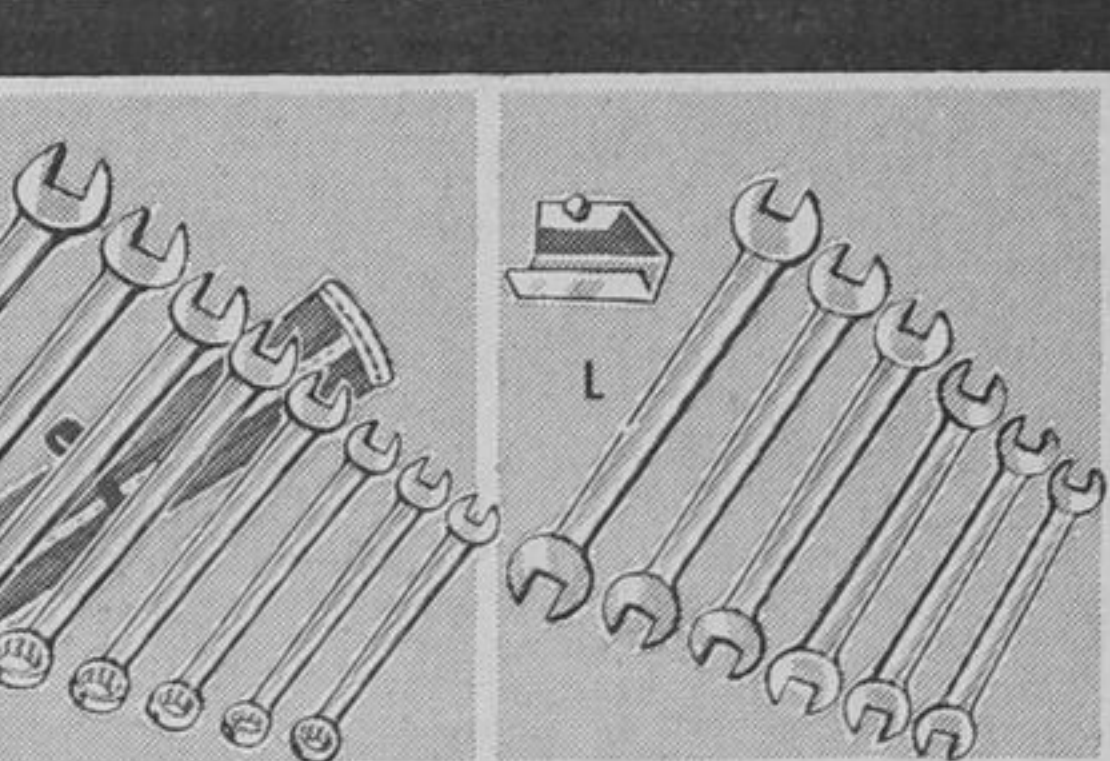

K. 8-PIECE COMBINATION WRENCH SET **1.29**
Open and box end wrenches are perfect for small, light duty work. 7/32 to 3/8.

L. 6-PIECE OPEN END WRENCH SET **5.79**
Metric sizes from 8 to 19 mm. Nickel-chromed, drop forged molybdenum alloy.

M. 7 INCH PETERSEN VISE GRIP **3.89**
Strong, curved jaws adjust, grip, clamp.

Extra! Cash Bonus COUPONS or Use Your Convenient Canadian Tire CREDIT CARD



CANADIAN TIRE
ASSOCIATE STORE
10288 Yonge Street, Richmond Hill
Phone 884-1196