

Vote for fairness on Oct. 10

Halton Region is one of the fastest-growing regions in Canada and Ontario's Places to Grow Plan is asking Halton to double its population over the next 25 years.

While Halton already has an identified \$300 million municipal infrastructure deficit, the provincial growth targets require over \$8.6 billion in additional municipal and provincial infrastructure.

To accommodate the growth required by the Province, Halton and its local municipalities will need approximately:

- 1,100 hospital beds
- 50 new elementary schools and 14 new secondary schools
- 25 community centres, 8 libraries and 1650 acres of parkland development
- 22 fire halls, 4 ambulance stations and six police stations
- 2,200 lane kms of major municipal roadways plus expansion to highways, bridges and interchanges

In Halton, we developed the Fairness for Halton campaign, and have been advocating to the provincial government to make some important changes so we can effectively meet the targets set out by the Places to Grow Plan. We know that the Places to Grow Plan will have significant impacts in Halton, so we think voters should be fully informed about each candidate's position before the provincial election on October 10.

What will each candidate do to ensure that

Gary Carr



municipal infrastructure funding programs are targeted at the infrastructure required to accommodate growth?

What will they do to ensure the objectives of the Fairness for Halton Campaign are met?

Are they willing to vote against their party if it means a better future for Halton?

To get the answers, we sent a questionnaire to all Halton Region candidates regarding Fairness for Halton and what they will do to achieve it with us. These questions and the answers we receive from candidates will be posted on Halton's website, www.halton.ca. I urge you to visit the website to find out more about the Fairness for Halton campaign and the issues facing Halton. You can also forward an on-line postcard to your local MP and MPP in support of the Fairness for Halton initiative.

Find electoral district information and confirm you're on the register by visiting www.electionsontario.on.ca. October 10 is election day. Don't forget to vote and make your voice heard.

—Gary Carr is the chair of Halton Region

Region now offering e-mail alert service for area residents

The Region is now offering an e-mail alert service for local residents.

Those who subscribe will receive automatic notifications on various topics, such as the lawn watering restrictions currently in place.

Citizens can also choose to be notified when there are delays in garbage and recycling pick-up or when advisories are issued related to smog, heat or cold. For more information on these initiatives or to sign up visit www.halton.ca.



THEATRE ORANGEVILLE

live. professional. theatre.

David Nairn - Artistic Director

A New Musical from Norm Foster, creator of *The Love List* and *The Long Weekend!*





One Moment

Book & Lyrics by: **Norm Foster**
 Music & Lyrics by: **Steve Thomas**
 Directed by: **David Nairn**

Subscriptions for the 2007/08 Season are available until **October 7**.
 Hurry and buy yours today!

Tel: 519-942-3423
 Toll Free: 1-800-424-1295
www.theatreorangeville.ca

September 20 – October 7, 2007

We'll Get You Started



Our state-of-the-art auto electric shop is equipped to handle even the toughest rebuilds. We have been diagnosing and repairing starters, alternators and pump motors for over 20 years, and we stand behind each and every repair with a comprehensive two year warranty - parts & labour. Affordable Rates!

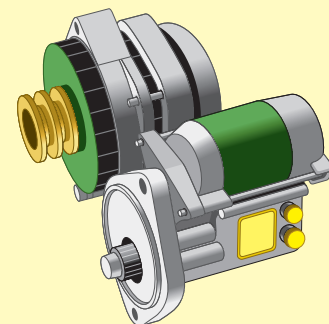

Alternators • Wiring • Starters

LUMA AUTOMOTIVE INC.



The Key To Your Driving Needs

**71 Mountainview Rd.
905-873-1632**