

### Region still seeks site

The Tremaine-Britannia Citizens Group has won a major victory in its battle against the proposed Halton regional landfill site, but according to its chairman, suggestions that regional council is abandoning its plans to establish the 250-acre dump in rural Milton are still far from accurate.

David Katz expressed pleasure and satisfaction Thursday with regional council's decision the day previous not to appeal an Ontario Supreme Court ruling which requires Halton to obtain Milton council's permission for the project. He pointed out, however, that more important confrontations before the Ontario Municipal Board (OMB) and the environmental assessment board (EAB) are forthcoming.

In voting to accept the supreme court ruling handed down March 29 by Mr. Justice James Southey, regional council rejected the recommendation of its solicitor, Dennis Perlin, who urged council Wednesday to pursue the matter.

The region must appeal the decision, he advised, because the "narrow interpretation" of the Municipal Planning Act upon which the court based its ruling could hamper future regional public works projects.

The court cited a section of the Act which requires the applicant, Halton Region, to win approval for official plan amendments before work can begin on any project. Regional council nevertheless heeded a warning from the legal consulting firm of McCarthy and McCarthy that the appeal would have only a 50 per cent chance of succeeding.

Mr. Katz explained that the region must now ask the OMB to order the town of Milton to amend its official plan and zoning bylaw. Project approval must also be obtained from the EAB, he said, which is still referring to Ontario's Environmental Protection Act for guidance in municipal affairs.

Mr. Katz called the protection act a "basically weak legislation" which could provide a relatively easy victory for the region. If, however, the newly-adopted Environmental Assessment Act replaces the protection act, as is expected in the near future, Halton could face a difficult battle to win approval from the EAB for the Milton dump proposal.

The later legislation, Mr. Katz noted, "asks a lot of pretty powerful questions", particularly about the project's anticipated social impact, and would require thorough justification of the dump site choice by the region.

The citizens group chairman stated that the dump opponents will ultimately appeal to the Ontario cabinet if the region wins the support of both the OMB and the EAB. He added, however, that the group's lawyer, David Estrin of Toronto, is already preparing for the OMB hearing and fully expects, along with the citizens, to win the case.

Among the factors involved in the dump proposal which the group contends the region has overlooked is the volume of ground water beneath the rural Milton site. Mr. Katz pointed out that it took only minor showers late last month to flood a portion of the so-called Bell School Road which runs close to the site boundary. The road had to be closed, he said, indicating that there is much more water beneath the site, which could be contaminated by a dump operation, than the region realizes.

Regional council also heard Wally Wells of M. M. Dillon consulting engineers firm outline six submissions for the construction of a resource recovery plant that would incinerate anywhere from 50 to 100 per cent of Halton's garbage for a capital expenditure by the region of between \$9.2 million and \$32 million.

Council voted to approach the ministry of environment for assistance in funding a "back end" recovery plant, a move which Mr. Katz praised. Back end plants, he explained, handled every scrap of garbage, whereas "front end" plants are only about 50 per cent efficient and as such still require some solid waste landfilling.

Mr. Katz said that the efficiency of a back end plant such as the facilities now in operation in Montreal and many other locations around the world has become a topic of debate for the region and the citizens group.

Regional council, he said, refuses to accept that such a facility totally eliminates the need for a landfilling operation of the kind proposed for Milton. Instead, the recovery operation, which can produce steam for energy or drive turbines to create electric power, leaves only an ash residue that can be safely dumped in old quarries or gullies.

# ASSISTANT MANAGER'S SALE

CONTINUES

Thurs. - Fri. and Sat. April 13-14-15

We reserve the right to limit quantities. Zellers sale prices will remain in effect until Saturday, April 15, or while quantities last. All advertised items available at or through Zellers stores.

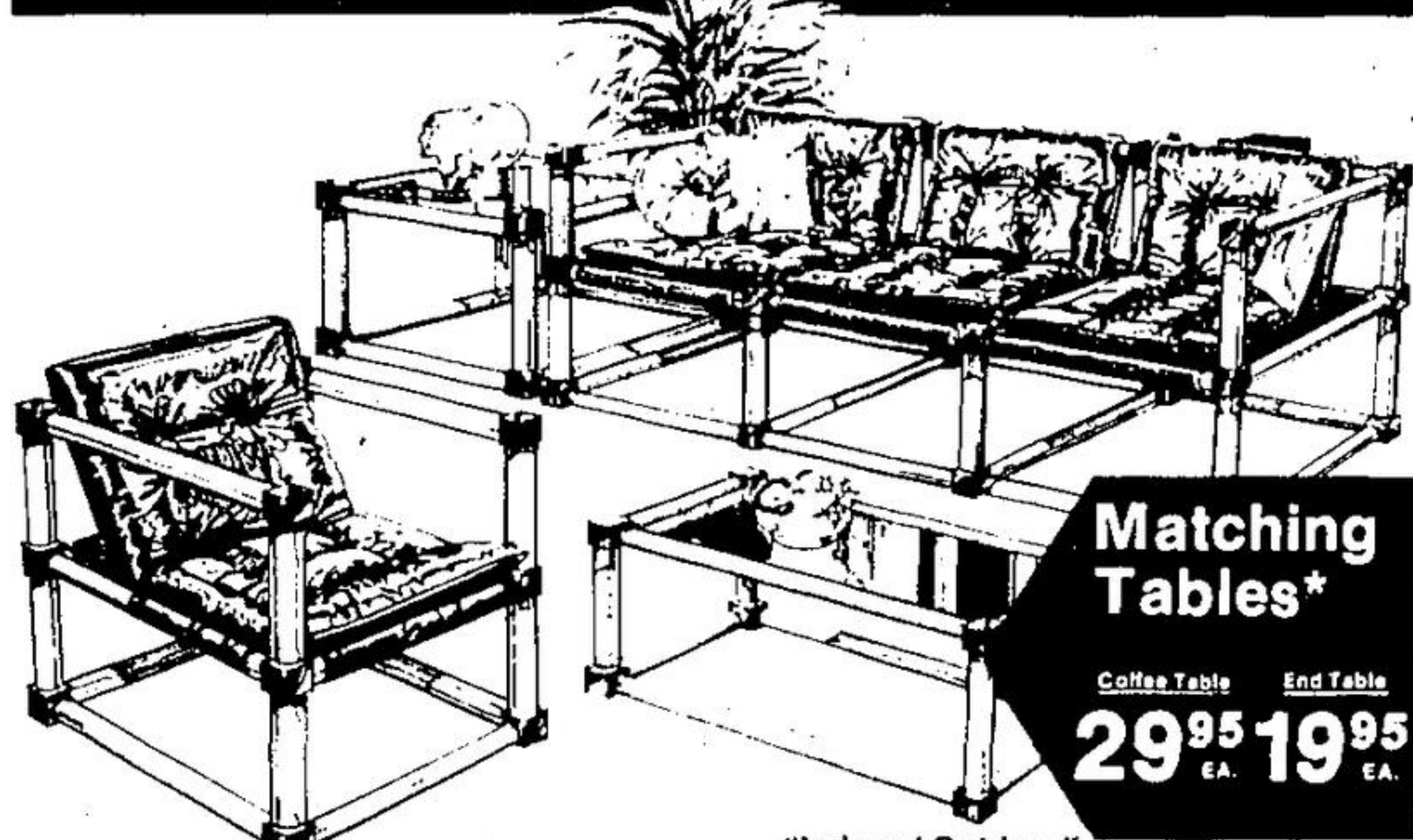

Matching Tables\*

Coffee Table End Table  
29.95 EA. 19.95 EA.



"Indoor / Outdoor"  
68" Sofa, Chair and 46" Loveseat Ensemble

\$188.30  
3 PCE SET

Extra Chair  
34.97 EA.

Extra Loveseat  
64.97 EA.

OUTSTANDING SPECIALS

Distinctive design will complement a wide range of room settings! Glossy plastic frames are scratch and fade-resistant. Comfortable 2" seats are upholstered in easy-care vinyl! Attractive lemon shade.  
\*Coffee table approx. 48" L x 18" W x 16" H. End table approx. 20" L x 20" H x 16" H.



Zellers "Big Big Buy" White Interior Paints

YOUR CHOICE 4.97 GAL.

Durable, long lasting white latex interior paint for walls and ceilings... washable alkyd semi-gloss or enamel semi-gloss for halls, kitchens and bathrooms. Your choice at important savings now!

Enamel Semi-Gloss  
Latex White  
Alkyd White

White "Stucco-Tex" 4.97 GAL.  
Exterior or interior white rough-texture finish.



Save Now On Motor Oil

87¢ QT.  
"Quaker State" "Super Blend" 10W-30 oil.

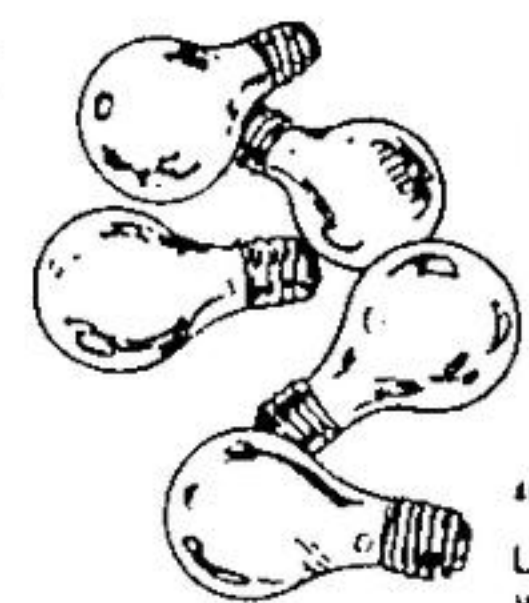

"C.G.E." Bulbs

77¢ PACK OF 2  
"Shadow Ban" Light bulbs in 40, 60 or 100 watt size.

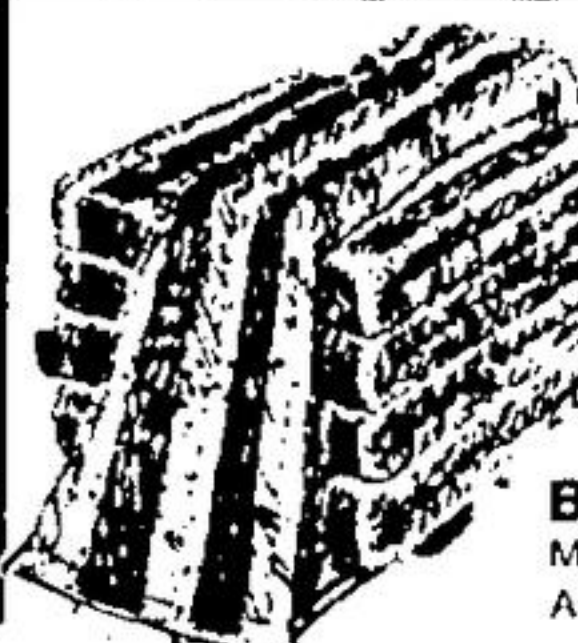

\$1 EACH  
Bath Towels Multi-striped cotton terry. Approx. 20" x 40"



6.97 EACH  
Tote Bags Four smart roomy styles in easy-care polyurethane. Colours.



Ladies' Knit Tops

Choice of 2 popular styles in assorted colours S-M-L  
2.97 EACH

Ladies' T-Shirts

Short sleeve cotton T-shirts in assorted solid shades S-M-L  
1.97 EACH

Women's Blouses

Polyester or queen suit in navy, brown, red, prints. Sizes 40-44  
6.97 EACH

Print Smock Tops

Machine-washable cotton. Assorted prints with solid trim S-M-L  
5.97 EACH

Lovely Cross Pendants

Assorted styles in gold or silver colours  
\$2 EACH

Men's Leather-Look Jackets

Six great styles, just 2 shown. Rich leather-look jackets in wipe-clean polyurethane-coated cotton with 100% nylon linings. Brick, luggage or walnut in styles shown. Best, tan, mahogany in others S-M-L-XL  
YOUR CHOICE 12.97 EACH



Men's Windbreakers

Choice of 3 styles! Cotton with nylon lining. Many shades in 36-46  
19.97 EACH

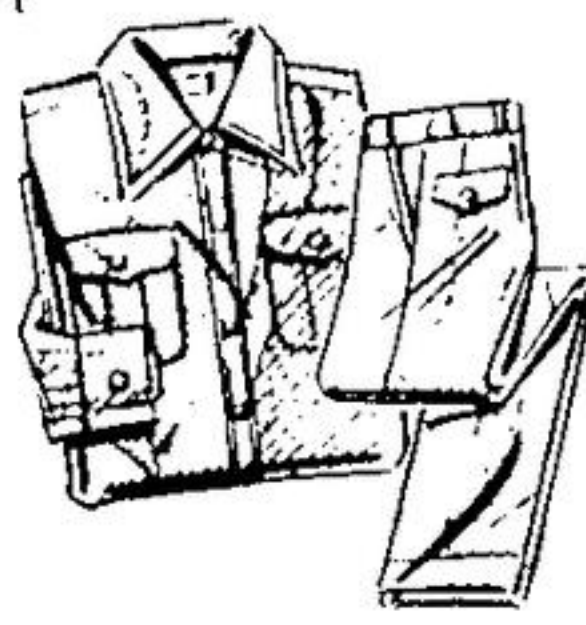

Men's Work Clothes Shirt or Pants

Machine-washable 100% cotton drill. Shirt 15-17", pants 30-42. Forest green  
3.77 EACH



Boy's Swamp Coats

Reversible hooded, rubberized cotton. Navy / yellow, green / yellow, 8-18  
6.97 EACH

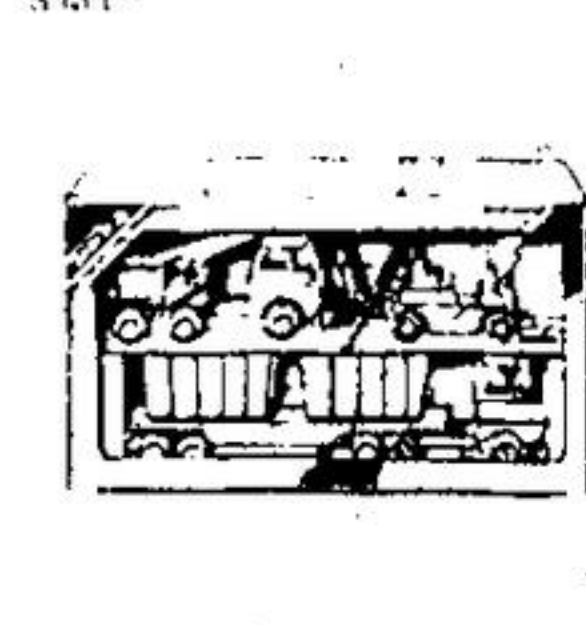

"Tonka" Gift Sets

Choice of 4-pce construction set or 3-pce material handling set  
SAVE 50% 3.97 SET



24" Skateboard

Fiberglass with kick-lait, thru-bolted trucks, urethane wheels 2-tones  
17.97 EACH

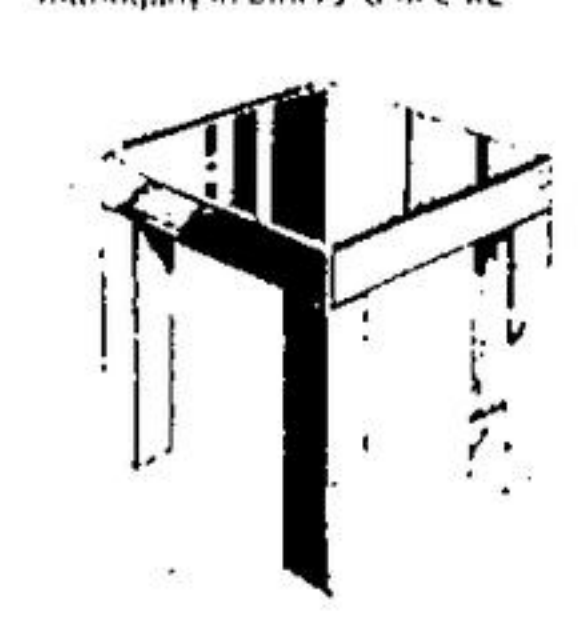

Parson Table

Sturdy 16 plastic parson table. Assorted colours  
4.99 EACH

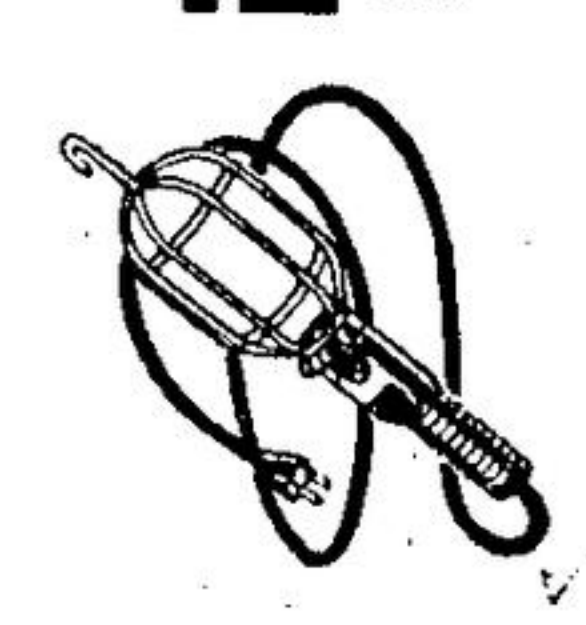

Trouble Light

Cage, bulb and 3 ft cord  
2.97 EACH

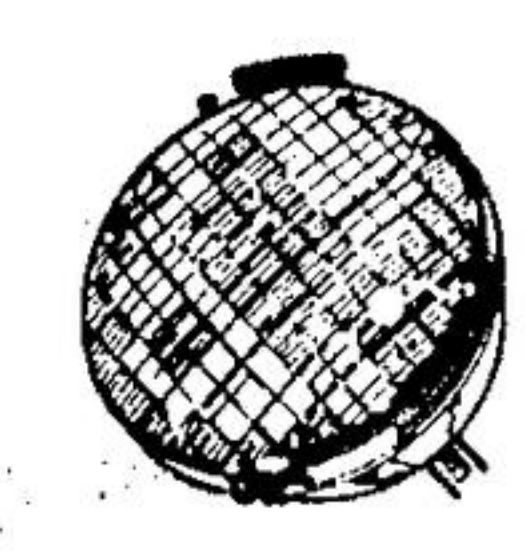

Sealed Beam

Replacement auto headlamp. 12.6 volts, 60 watt.  
2.27 EACH

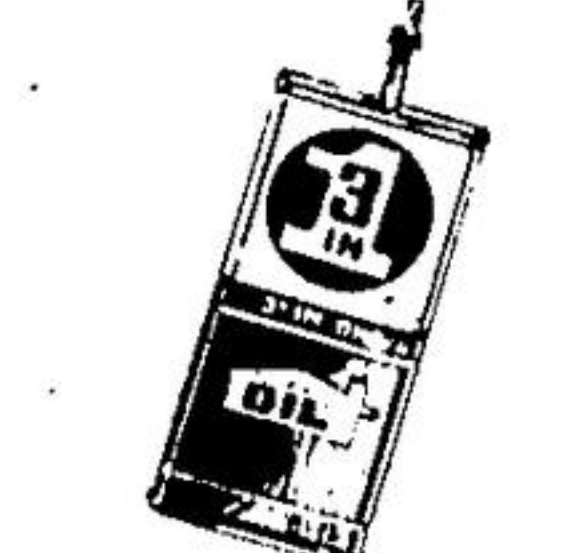

"3-In-1" Household Oil

Keeps things running smoothly  
89¢ 3-OZ



"Eveready" Batteries

Heavy duty AA, D or C cells, pack of 2. 9 volt pack of 1  
YOUR CHOICE 97¢ EACH

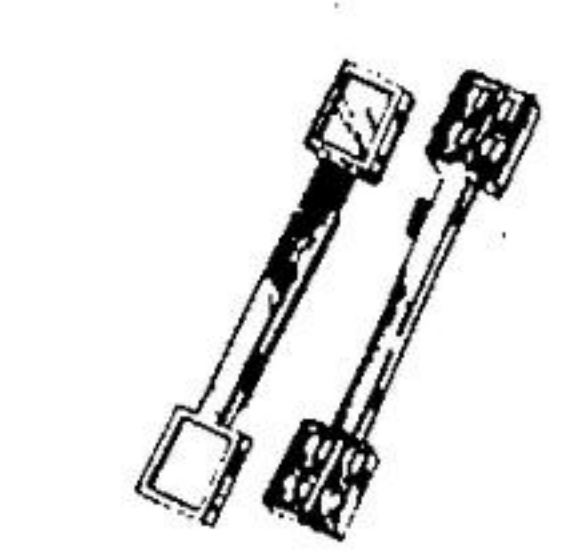

Furniture Roll-Out

White roll-outs to make heavy furniture easy to move  
1.67 PR.



"Pan Handler"

By Proctor Silex. Cooks eggs, crepes, hamburgers, steaks.  
19.97 EACH



Frozen Food Knife

A "must" for every freezer owner!  
1.47 EACH

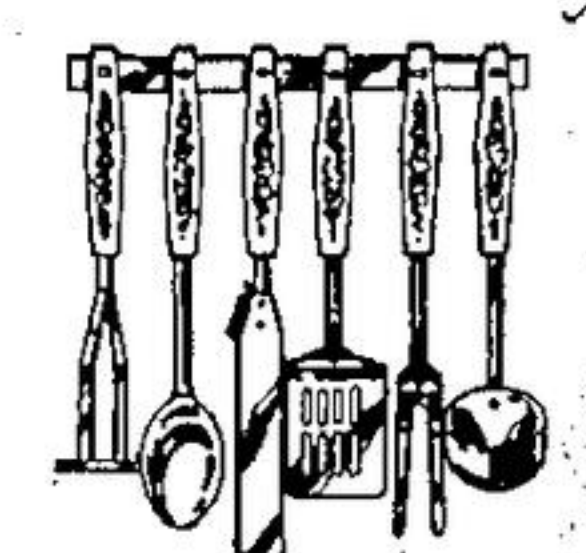

7-Pce. Tool Set

Stainless, with floral or woodgrain handles. Rack included.  
6.97 BOXED SET



Credit Convenience at Zellers! Any of These Credit Cards Accepted!

IN THE GEORGETOWN MARKET PLAZA

Open Monday to Friday till 9 p.m. - Saturday till 6

