



PREPARING FOR A CAREER

Twelve-year-old Mike Williams is getting an early start on a medical career. Last week the Grade 8 pupil at Centennial school who wants to be a doctor, demonstrated the anatomy of a frog compared to the human body in a series of dissections he carried out at the school's annual science fair. When the Herald photographer snapped his picture he was opening his third frog and still had a supply of about 10 more, which, he commented, would not likely be used. The science fair consisted of a series of displays by the school pupils and varied from experiments in making hydrogen to the effect of light on sound waves, properties of rising heat and the action of a volcano.

Agricultural Briefs

HALTON WHEAT PRODUCERS' ANNUAL
Charles Martin, Milton 1, was chosen as Committeeman from the Halton Wheat Producer's Association to the Ontario Wheat Producer's Marketing Board at the Halton annual meeting on February 17th in the Agricultural Office, Milton. Alternate Delegate is Joe Stutz, Milton 1.

Bruce Clark of Caledonia, a Director of the Ontario Board stated that 21,800,000 bushels of winter wheat had been purchased last year with 7,400,000 bushels sold for domestic use, 720,000 bushels for seed, 33,000 for feed, 9,600,000 for export, and 5,700,000 bushels still in storage. The world wheat market is depressed because of the high yields throughout the world last year. Russia had a 50 per cent increase in wheat production. The world market is currently close to the \$3.00 per bushel range. Last year the price received by Ontario farmers was \$3.68 per bushel.

This past fall there was a great increase of acreage planted to winter wheat in Ontario with a possible 30,000,000 bushels harvested this fall. Since February 1st all grains in Ontario are being sold on the metric basis. Mr. Clark stated that the University of Guelph are conducting research on varieties of winter wheat to try to control the excessive sprouting which occurred last year. Several farmers in Halton had to sell their sprouted wheat for feed rather than to the mill for higher prices.

HALTON-PEEL EGG PRODUCERS' ANNUAL
The Halton-Peel Egg Producers met for their annual meeting at the Golda Restaurant, Milton, on February 14th. It is some years since the last meeting of the Halton-Peel Egg Producers but an excellent turnout resulted from the initiative of the secretary, Mrs. Velma Ella. Stan Steen, the Director on the Ontario Egg Producer's Marketing Board from this zone and Jim Johnston, Chairman of the Board, were in attendance. A new quota transfer policy for egg producers is to be announced by their annual meeting on April 13th.
George E. Crompton of Markham, Chairman of the Retail Merchants Association of Canada, was guest speaker.

Limehouse News

By MRS. A.W. BENTON
Mr. and Mrs. Allen Brecken and Mrs. Evelyn Bullock holidayed at Edgewood and Clearwater Florida this winter.
We are sorry to hear that Mr. Sam Gisby and Mr. Archie McDonald are both back in hospital.
Many local pupils lost another day at school on Thursday as buses did not operate due to the slippery roads. Services at Limehouse Presbyterian Church were cancelled on Sunday due to dangerous travelling conditions.

Electrical Utility Restructuring

NOTICE Of Public Meetings

Public Meetings for the purpose of receiving verbal or written submissions regarding Electrical Utility Restructuring in the Regional Municipality of Peel will be held as follows:

MARCH 7, 1977 - Town of Caledonia Municipal Offices (Council Chambers) Number 20 Sideroad (Church Street) Caledonia East, Ontario 7:30 p.m.

MARCH 16, 1977 - Square One Auditorium (entrance near Cork Screw Tavern)

MARCH 29, 1977 - City of Brampton (Council Chambers) 24 Queen Street East Brampton, Ontario 7:30 p.m.

Written submissions may be forwarded to the undersigned up to and including March 30, 1977.

The Resource Group Report containing technical and financial information on the various alternatives for Electrical Utility Restructuring along with the preliminary proposals of the Local Study Team may be obtained from the undersigned.

J.W. Dillane Secretary
Local Study Team
3rd Floor 150 Central Park Drive
Bramalea, Ontario.
L4T 2V1



BEAVER

Selection & Value for the DO-IT-YOURSELFER

**Great Choice, Great Value!
Tools for your Workshop**

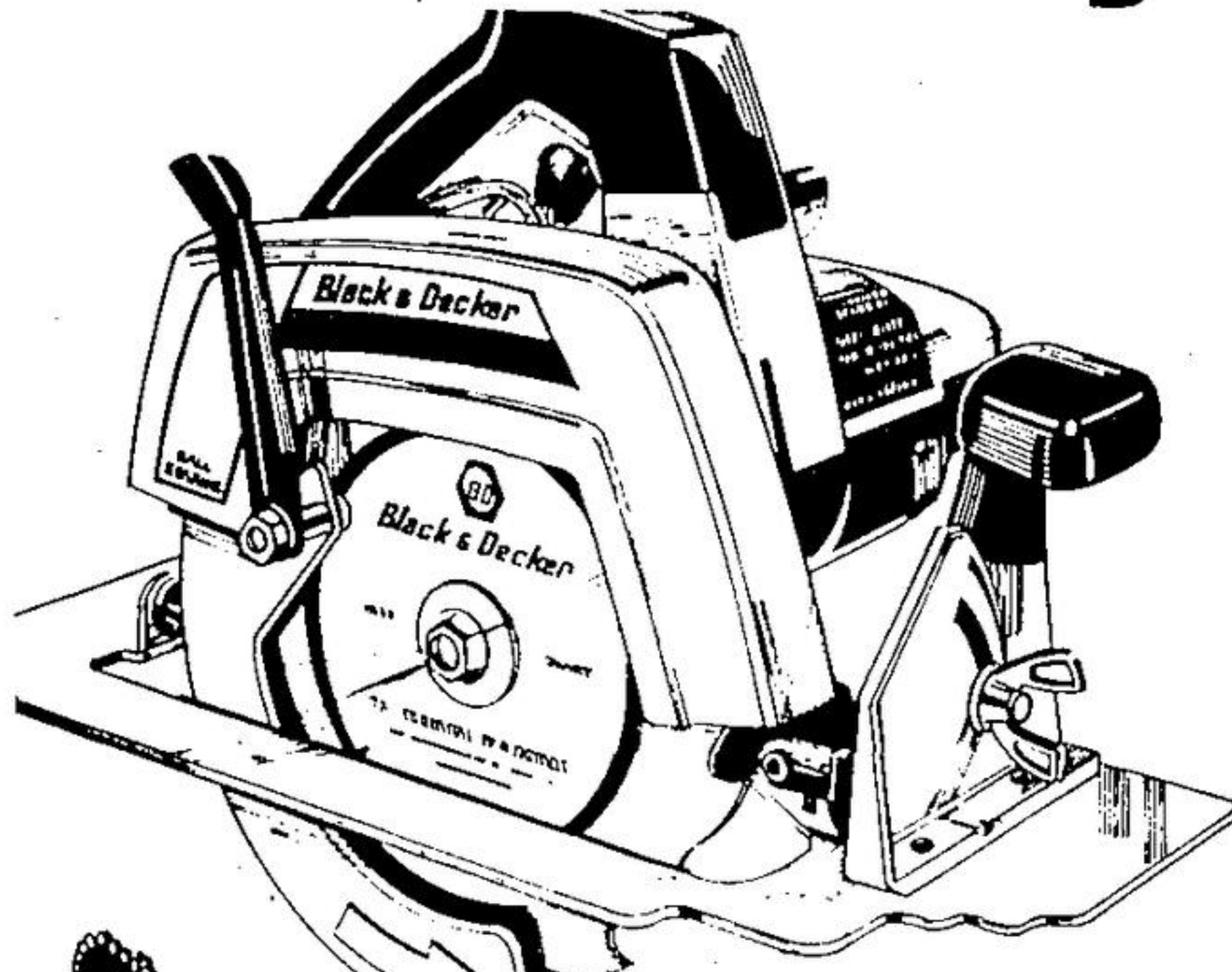

B & D 7 1/4" Circular Saw

Powerful motor with burn-out protection. Wrap-around shoe gives firm support. Long lasting ball and roller bearings. Heavy cast aluminum quadrant for accurate level settings. Auxiliary knob for added support. C.S.A. approved. 10 amps.

54⁹⁵ #7340

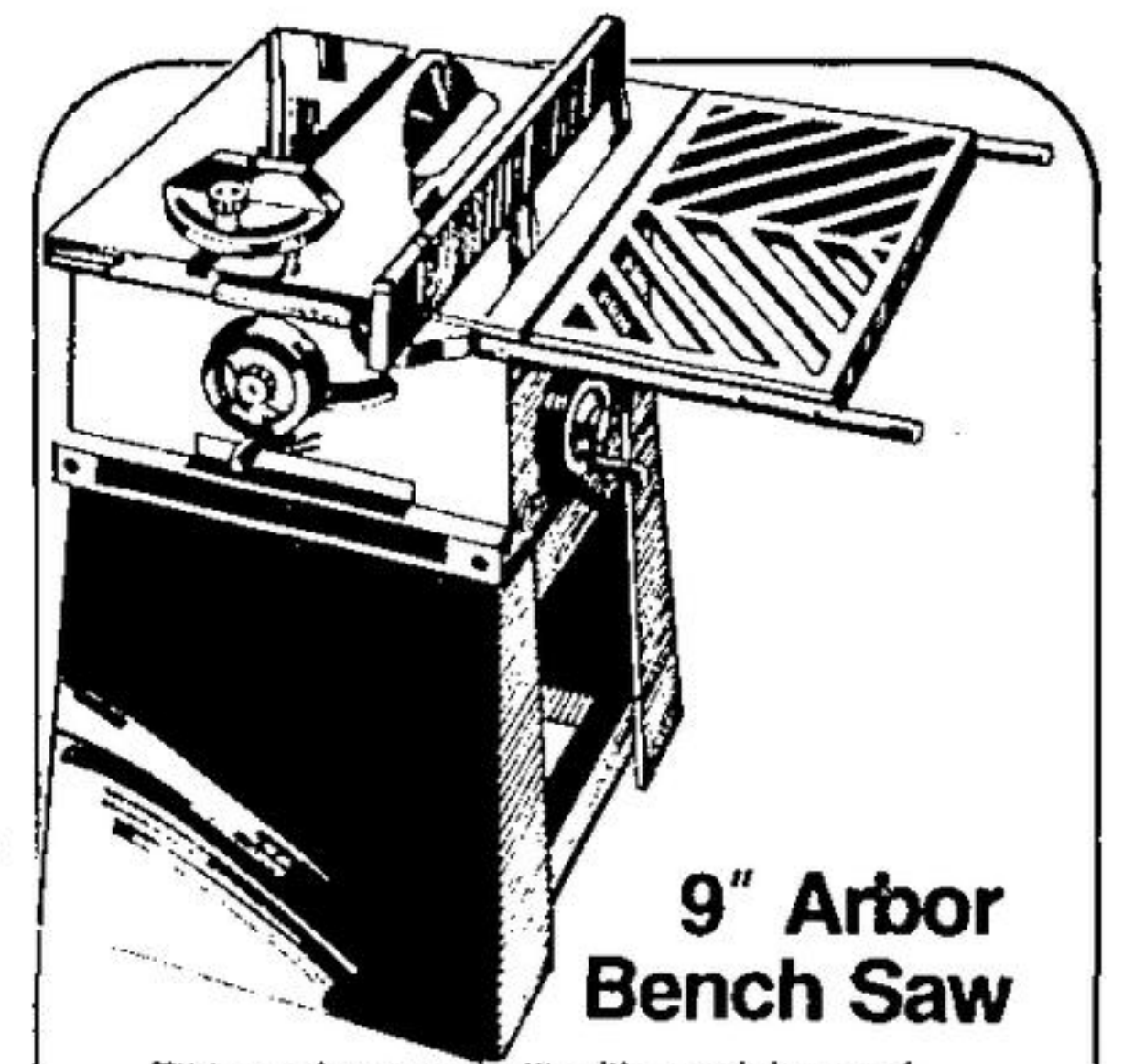

9" Arbor Bench Saw

Tilting arbor saw built with precision and accuracy. Safe and handy up front controls. Easy to read tilt scale that facilitates angle settings. 2 1/4" depth of cut. Precision ball bearing seats. Complete with large 22" x 50" table (with extensions.) A super buy!

219⁹⁵ Complete With Stand

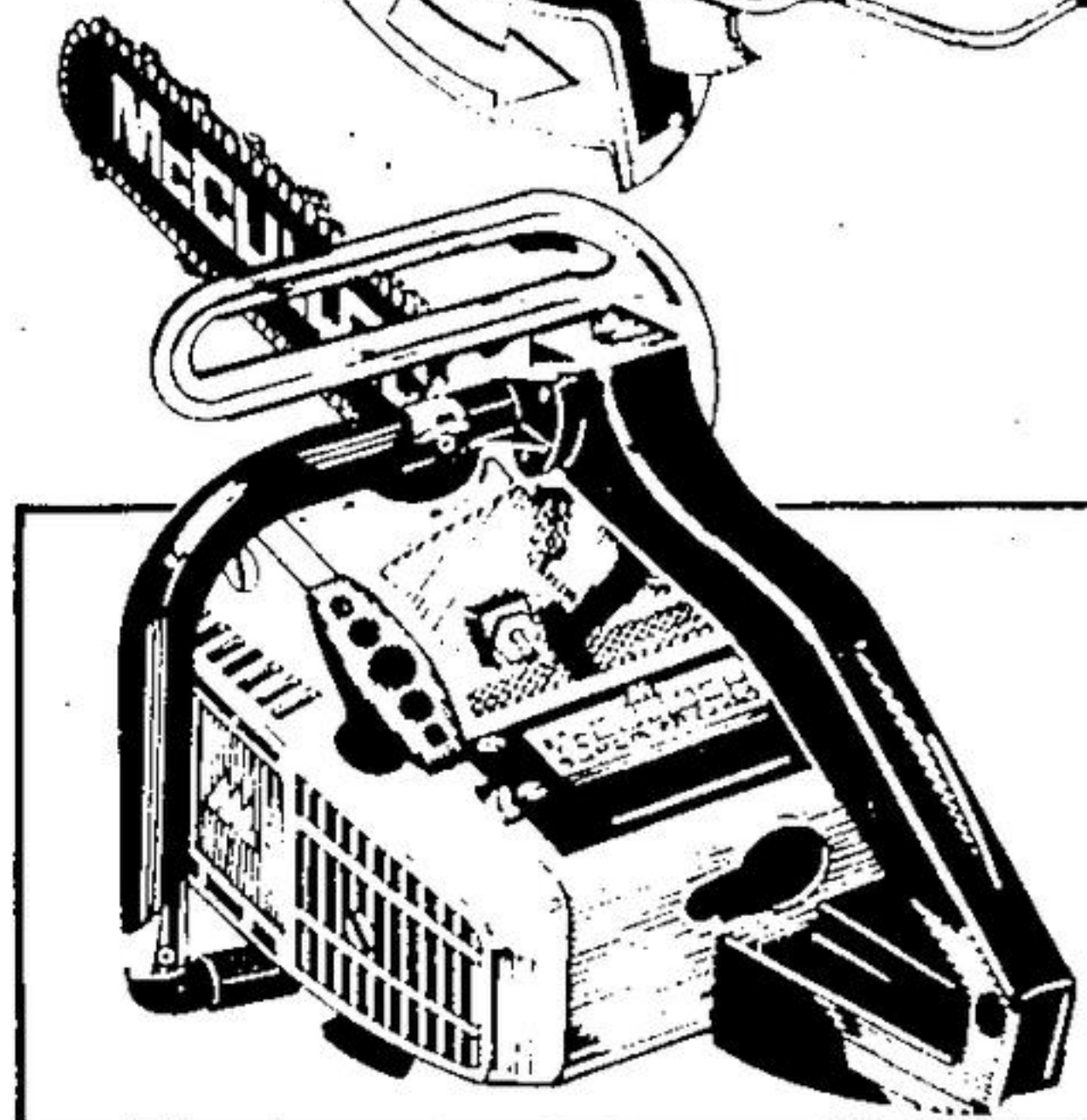

14" Super Pro Chain Saw

A super powerful small saw! Has an automatic clutch, rewind starter and oiler. Has special "cushion power" with anti-vibration system. 14 bar cuts logs up to 28". All-position carburetor operates at any cutting angles.

169⁹⁵

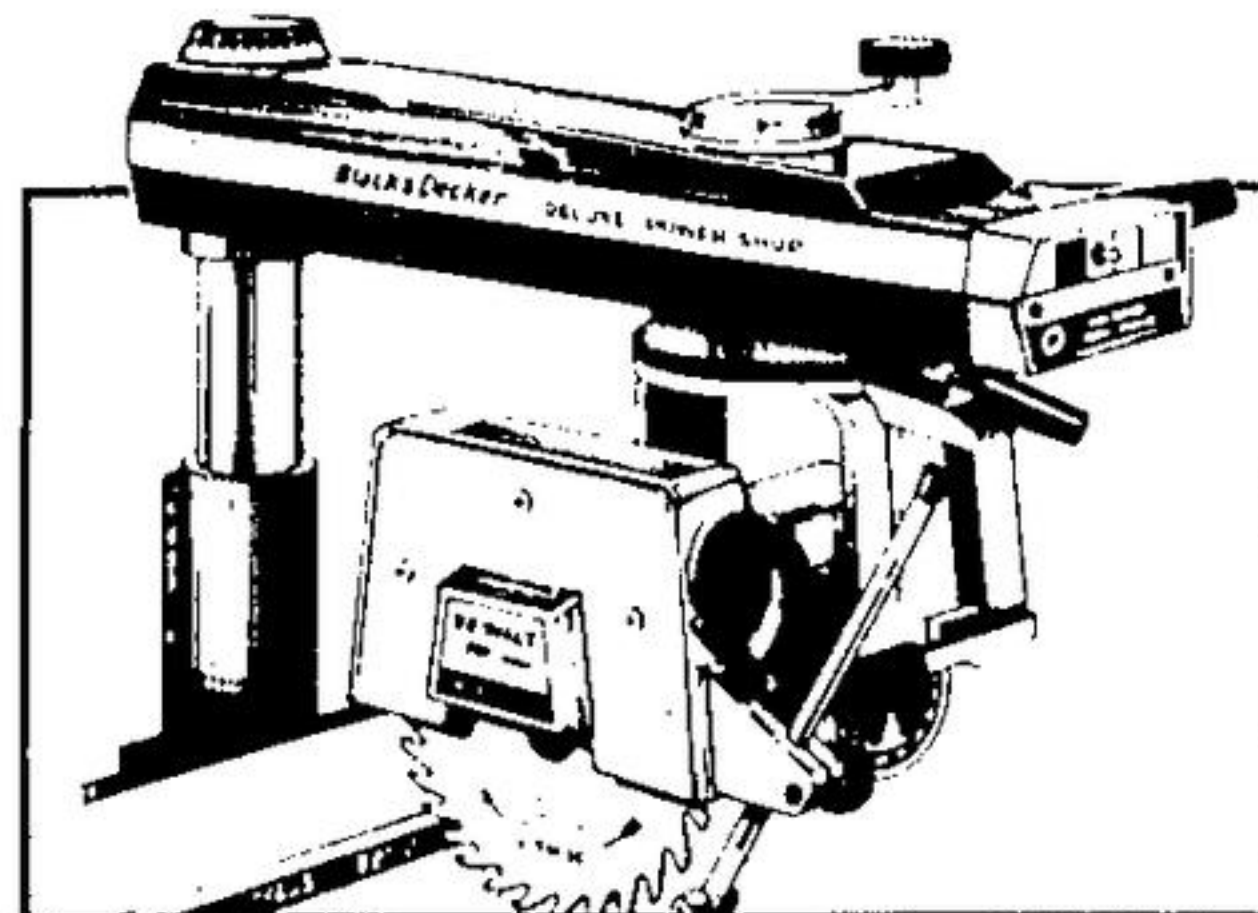

10" Radial Arm Saw

Single voltage direct drive motor. Manual motor brake. Roller head rides on 2 precision machine tracks. On top up front controls.

289⁹⁵ #7740

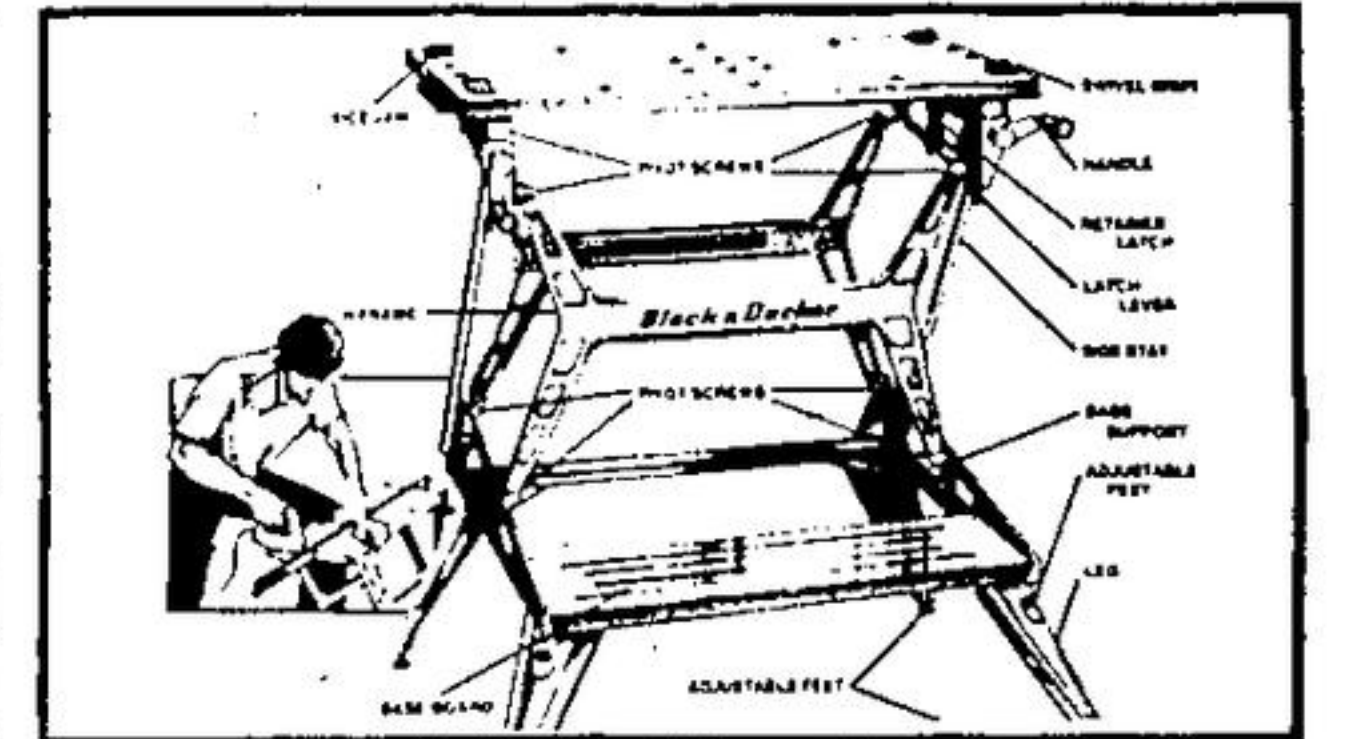

B & D Workmate

A foldaway portable work centre, giant vice and sawhorse all in one! Giant 29" vice has 4" jaw opening. Feet adjust for stability. Lightweight. Legs fold to adjust height.

59⁹⁵

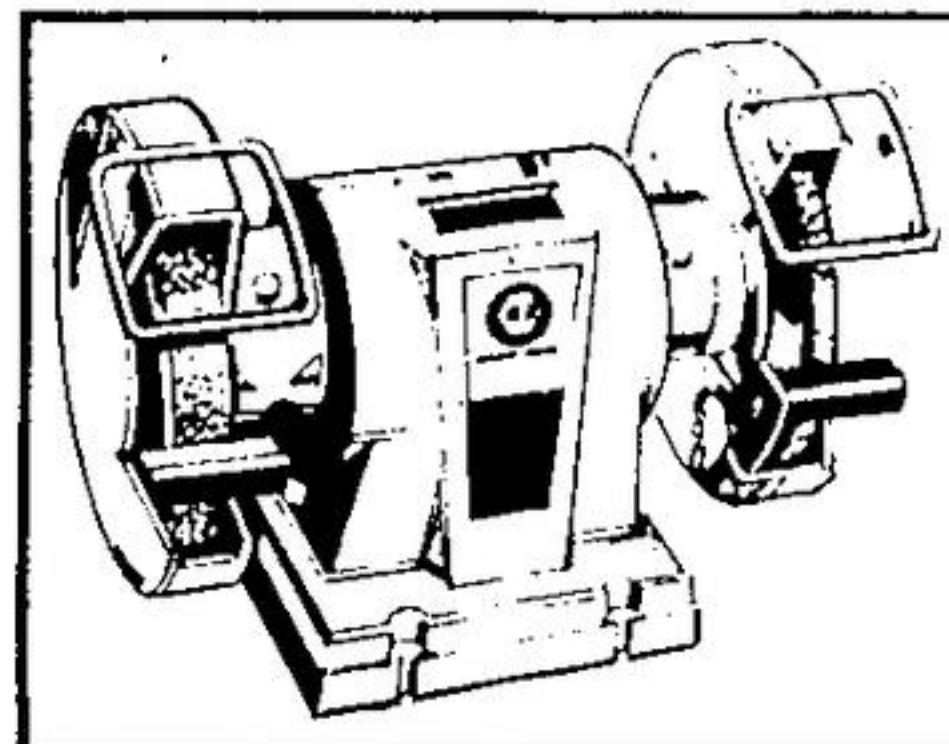

B & D Bench Grinder 3/8" B & D Drill

5" utility grinder with wheels that sharpen knives, hatchets, drill bits, lawn mower blades, etc. 5" medium and coarse grinding wheels.

39⁹⁵ #7900-04

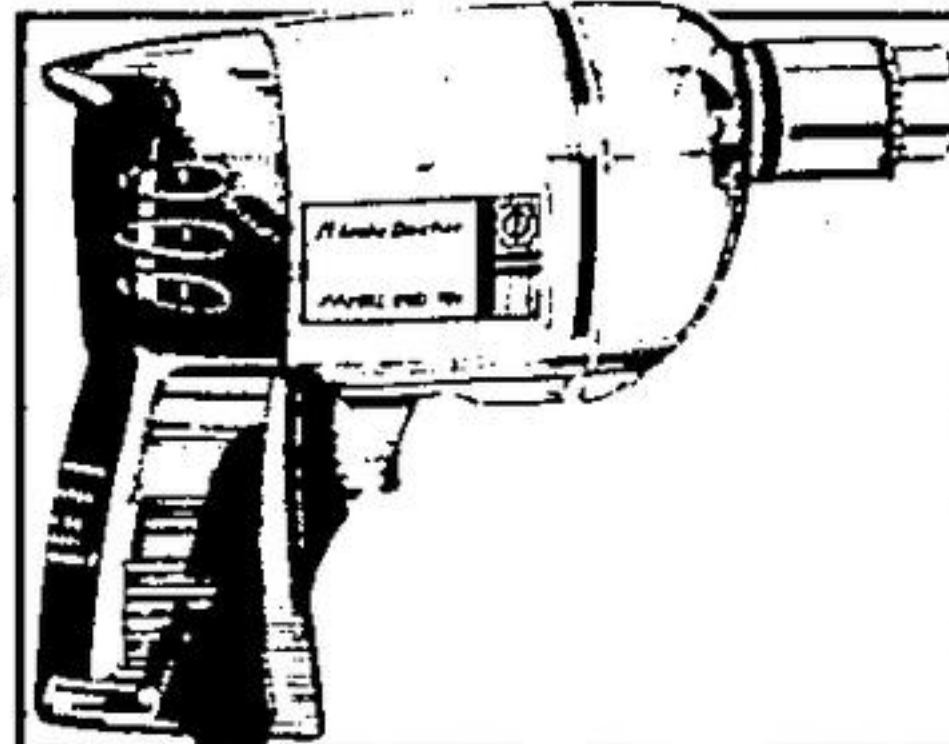

3/8" B & D Drill

Variable speed reversing drill that doubles as a screwdriver. Trigger-lock for continuous operation at any speed. Double reduction gearing.

22⁹⁵ #7140

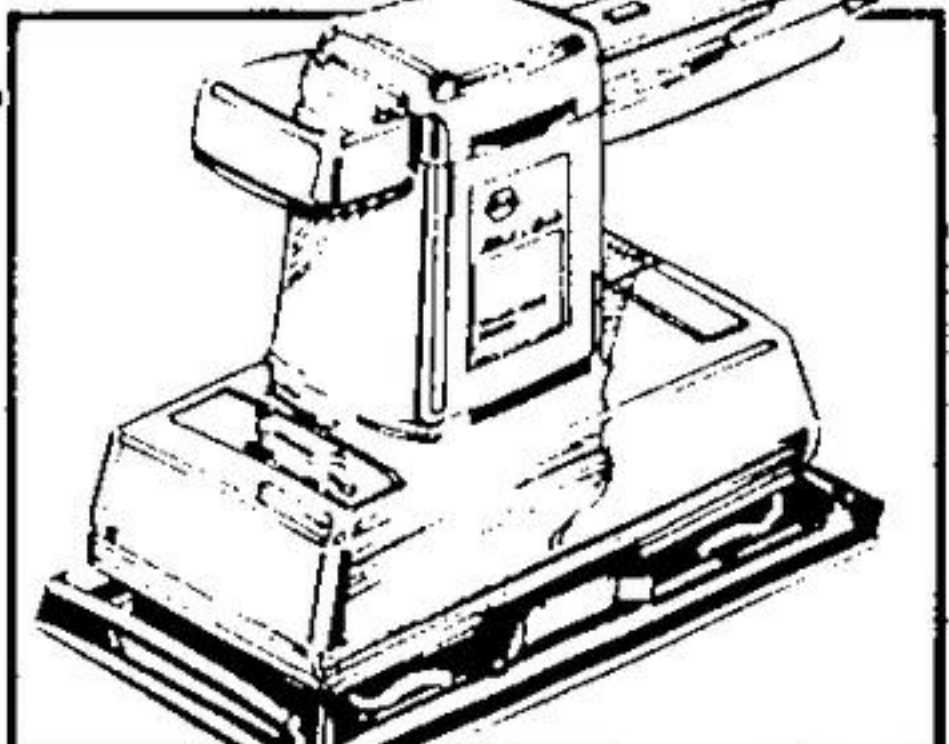

Finishing Sander

Large 4 1/2" x 11" sanding surface. Fast orbital action. Double insulated. Exclusive detachable 6' cord feature. 3 amps. A great gift idea, too!

25⁹⁵ #7480-04

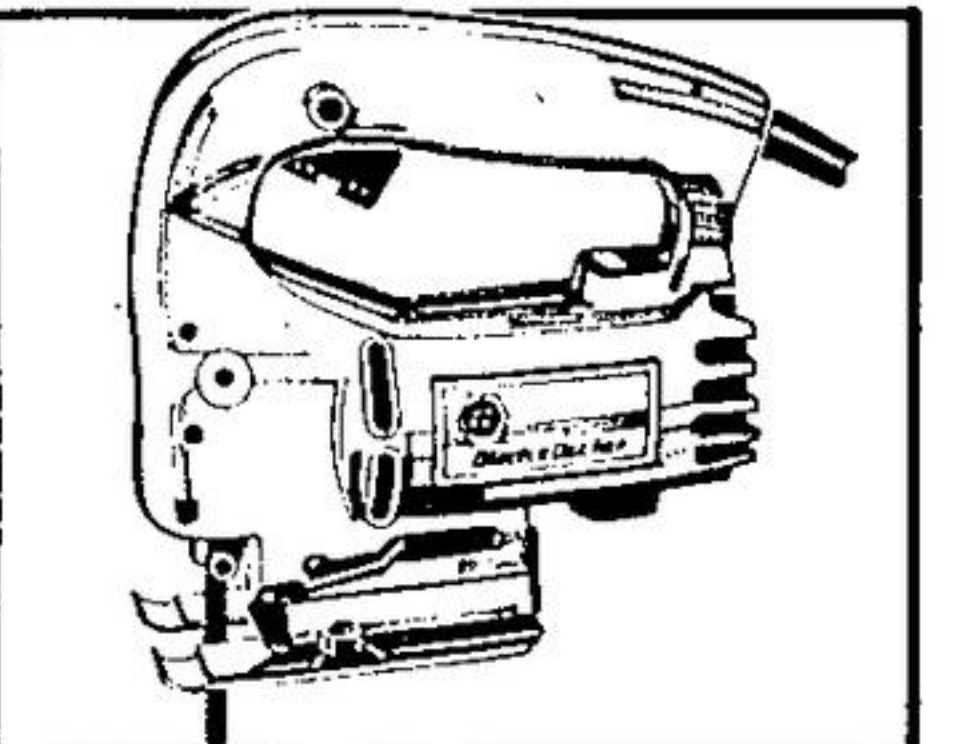

B & D Jig Saw

Variable speed jig saw that gives the right speed for the right job. Gives better control. Includes one blade. 2.5 amps.

29⁹⁵ #7560

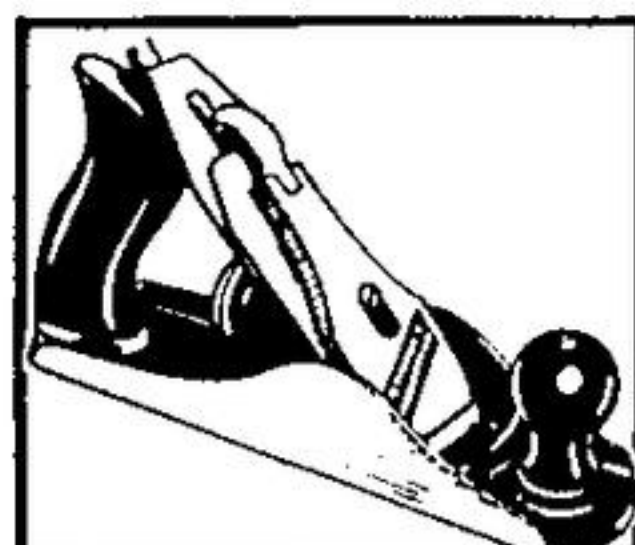

9" Bench Plane

Smooth planes for handyman. Gray iron castings. Cutters are tempered tool steel, adjustable.

11⁹⁵

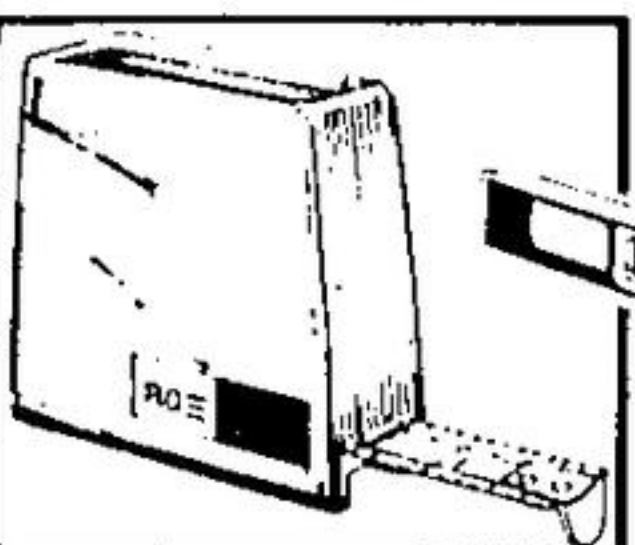

Tape Measure

Automatic lock hold. Blade when extended. Lightweight ABS case. English graduation.

5⁹⁵

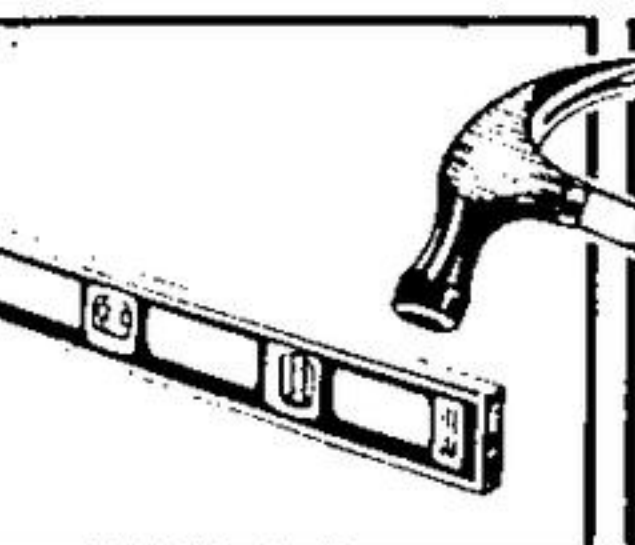

24" Alum. Level

Extruded aluminum body. 360 vials. Warp-proof. Each has snap-on dust-proof vial covers.

10⁴⁹

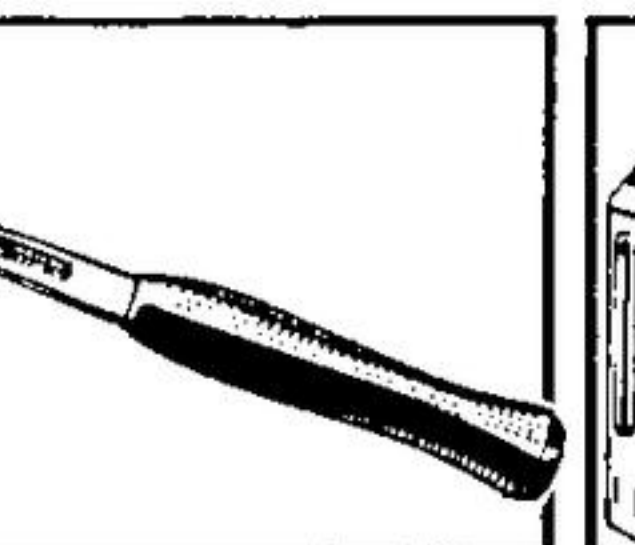

Claw Hammer

Curved claw hammer with steel shaft. 16 oz. Baked enamel finish.

6⁸⁹

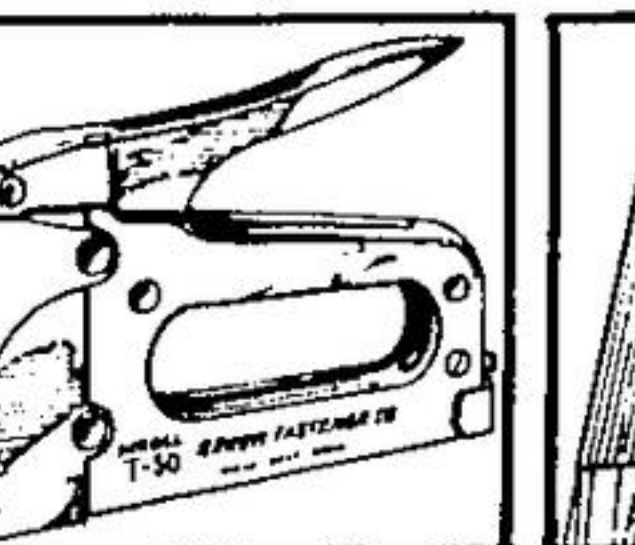

Arrow Stapler

Heavy duty stapler. Precision made of all-steel with a jam-proof mechanism.

15⁸⁹ T50

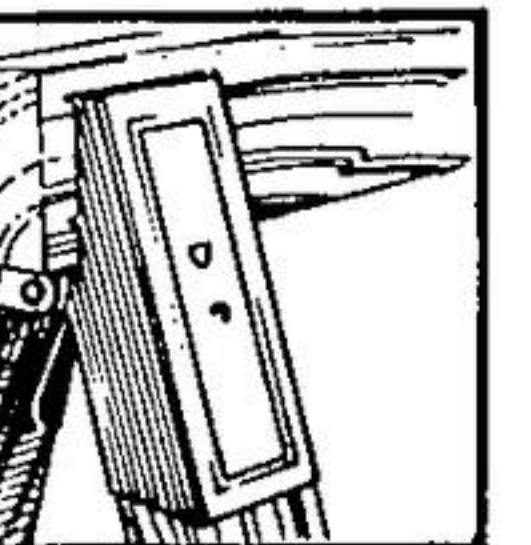

2' x 4' Brackets

Easy to assemble saw horse brackets. Safe and reliable. Easy to dismantle for transport.

2²⁵ Pr.



STORE HOURS: * Mon. 9 a.m. - 6 p.m. * Tues. 9 a.m. - 6 p.m.
* Wed. 9 a.m. - 6 p.m. * Thurs. & Fri. 9 a.m. - 9 p.m.
* Sat. 9 a.m. - 6 p.m.

316 Guelph Street E., Georgetown — 877-2234.

WE ACCEPT
• Beaver Charge Accounts
• Charge
• Master Charge