

SINGER SALE-A-THON

This way for sensational savings!

The Touch-Tronic* 2001 memory machine

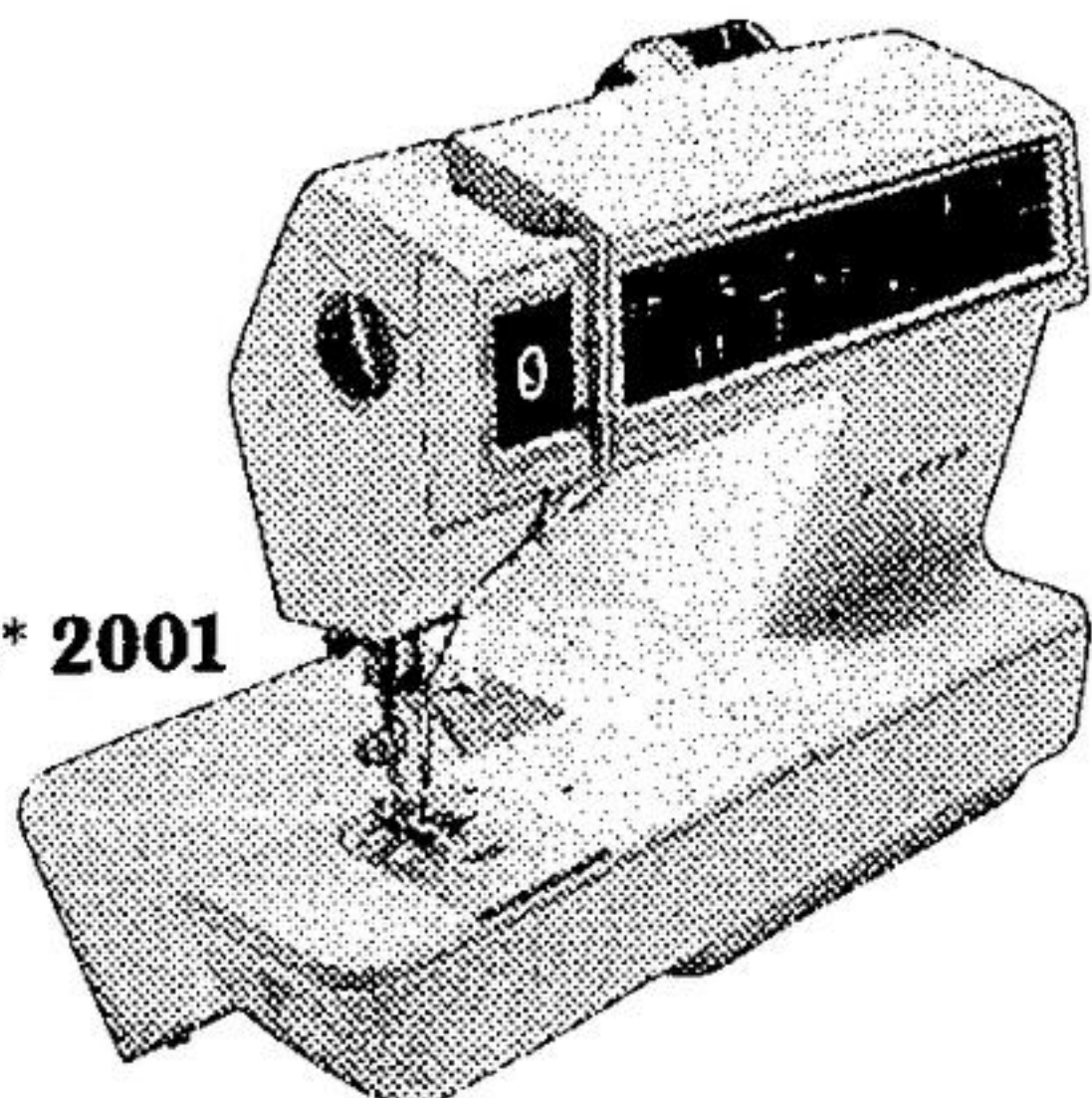

Only Singer makes the extraordinary Touch-Tronic 2001 with Singer exclusive Touch-Tronic memory panel; 27 pre-programmed stitch patterns; unique one-step buttonholer, Flip & Sew* panel and much more! Sale-A-Thon priced at \$1099.00.

SAVE \$100

PRESENTING...
The greatest show of scissors.
10% OFF! This week only!

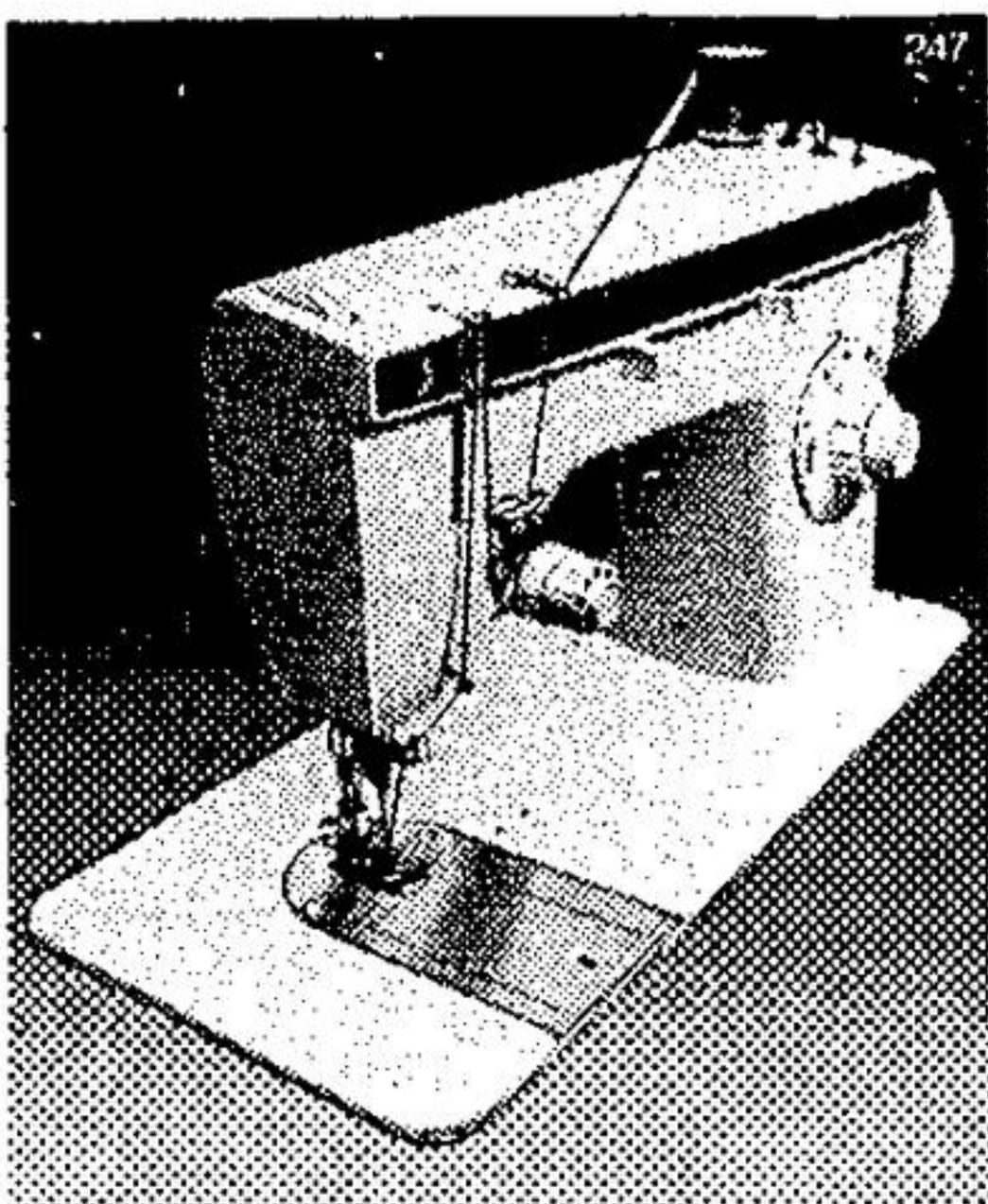

The Fashion Mate* ZIG-ZAG machine

Hurry, hurry! Take advantage of this fantastic offer NOW! This versatile machine has all your favourite features. Start sewing your Fashion Mate wardrobe, today! (Carrying case or cabinet extra.)

\$139

The Touch-Tronic* 2000 memory machine

Right this way... for daring, death-defying savings on a dream of a machine! Features Singer exclusives like one-touch electronic stitch selection, one-step button-measuring buttonholer, Flip & Sew* panel... and more! Sale price \$924.95 (Carrying case or cabinet extra.)

SAVE \$100

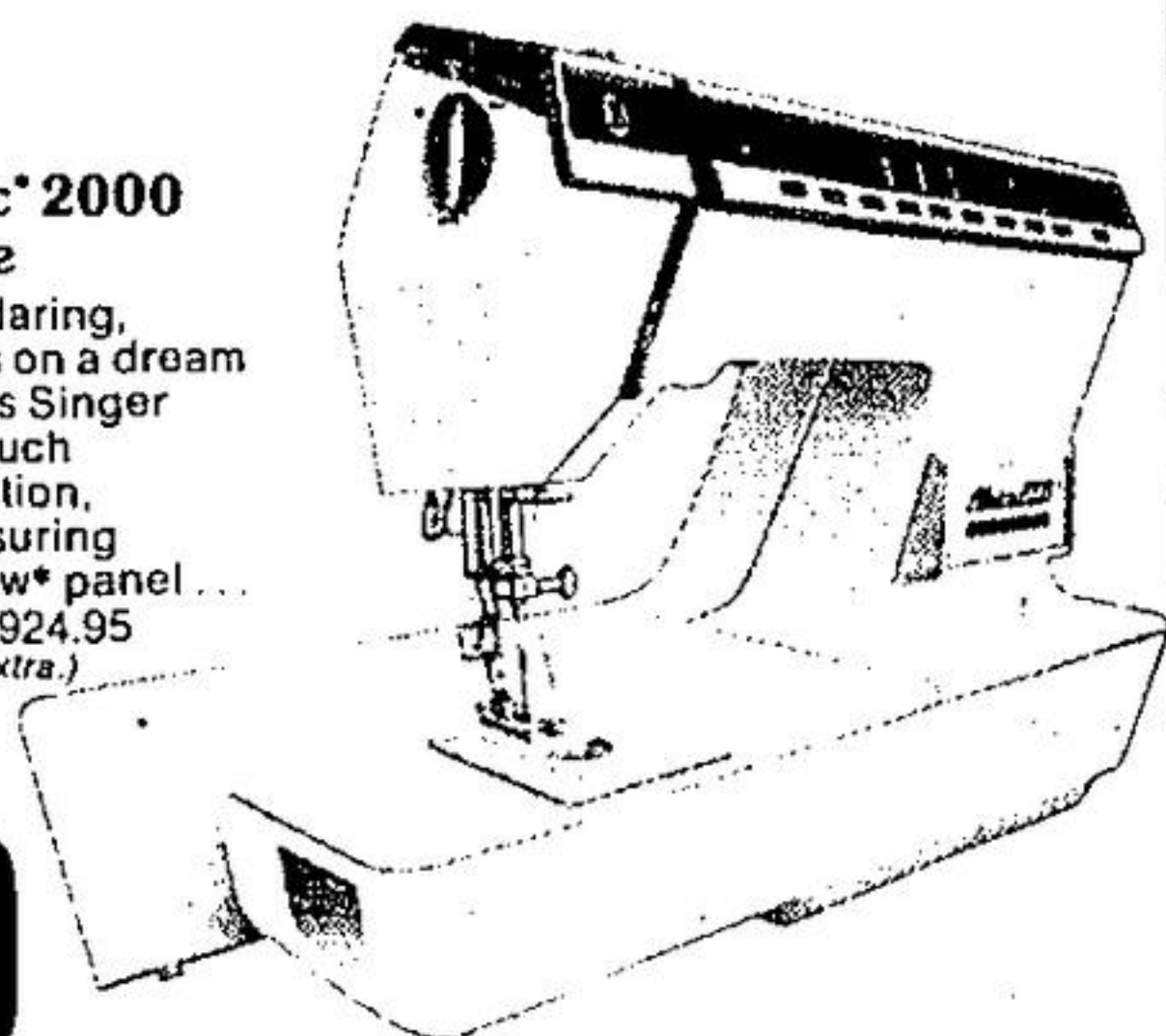

The Deluxe FREE ARM Stretch Stitch machine

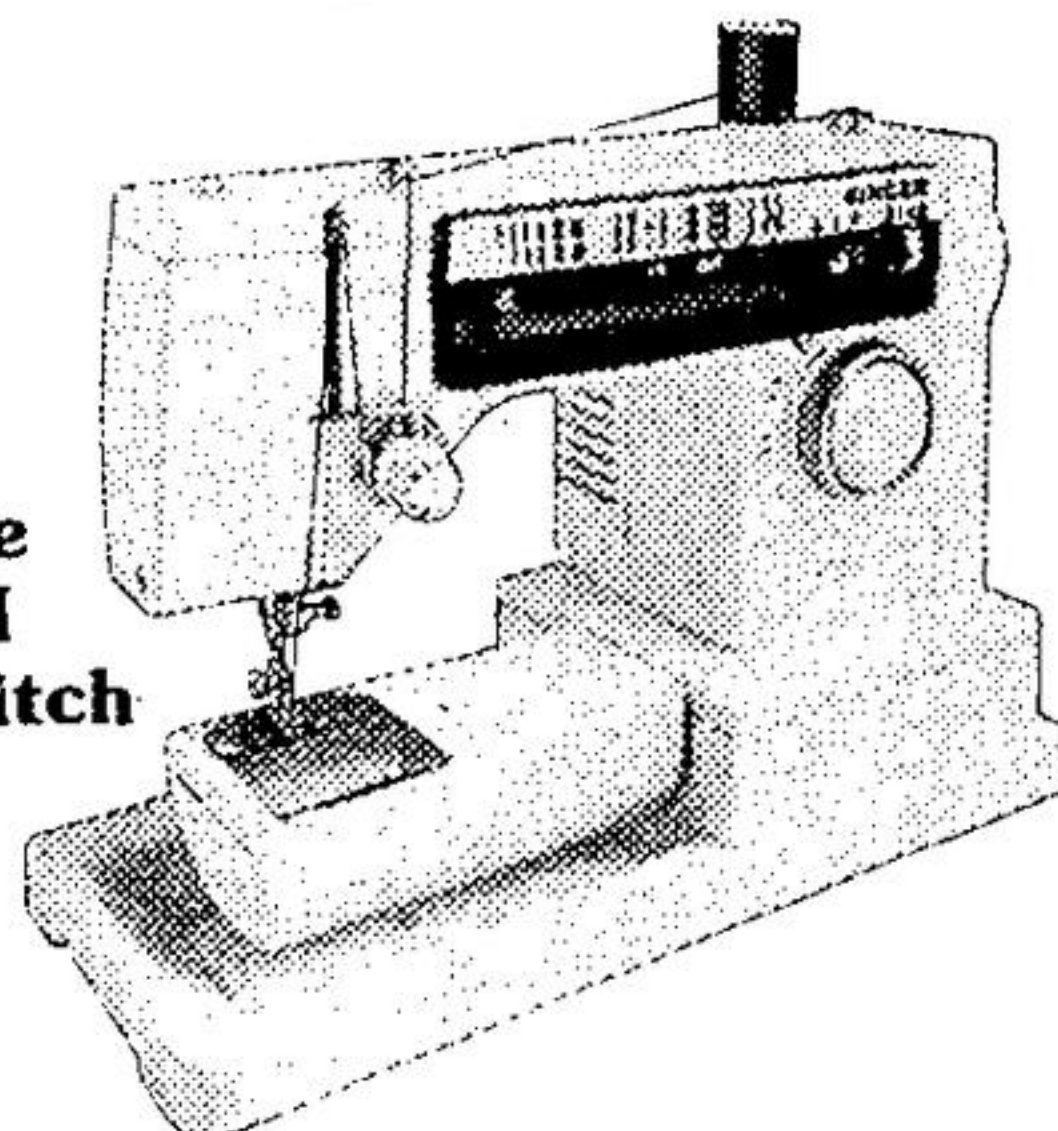

Don't miss the savings on our show-stopping Canadian-made sewing machine. And don't miss the features: buttonholer and 14 stitches built in; electronic speed control. Sale-priced now at \$414.95 Model 6146

SAVE \$50

Power Glide Economy Canister Vacuum Cleaner

- lightweight — durable construction
- permanent built-on tool case
- air-jet blower
- double filter system

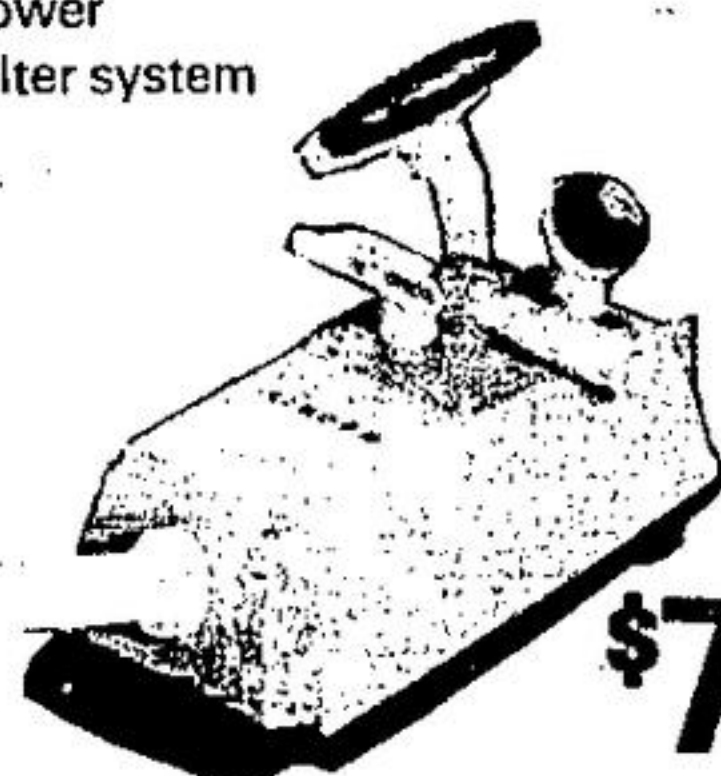

\$79⁹⁵

Memo-Matic — Quick & Easy Knitting

NOW ONLY Reg. \$519.95

\$469⁹⁵

- twin yarn feed
- Singer punch card patterns
- magic point motifs
- fun, quick and easy
- free lessons

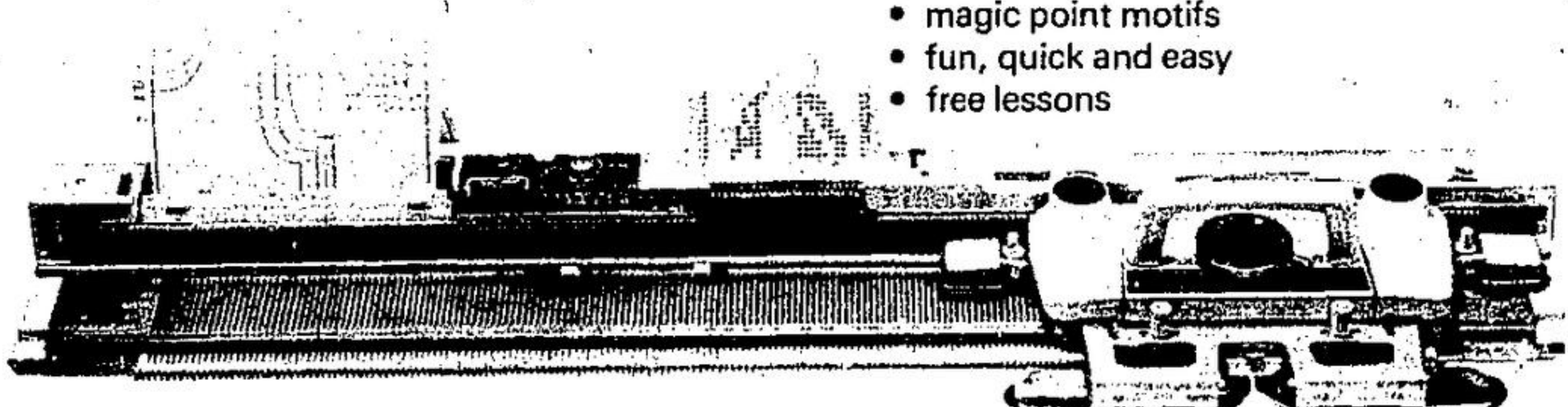

SAVE \$65⁰⁰

Our feature-packed Contempra Touch and Sew* machine at \$699.95. Our exclusive one-step button-measuring buttonholer makes perfectly sized buttonholes.

Our exclusive push-button bobbin-winder winds in the machine saving time and thread.

Our exclusive slant needle is easier to see.

Our exclusive soft-touch fabric feed guarantees smooth feeding of all fabrics.

Our horizontal thread delivery eliminates drag and gives more uniform tension.

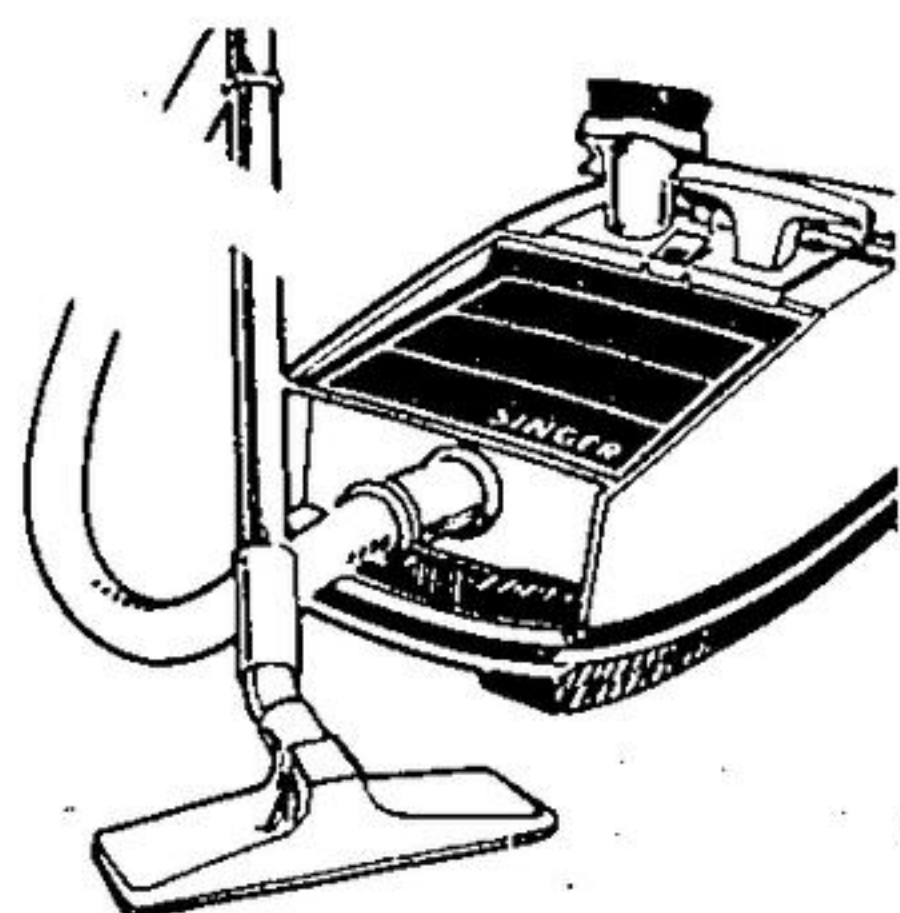
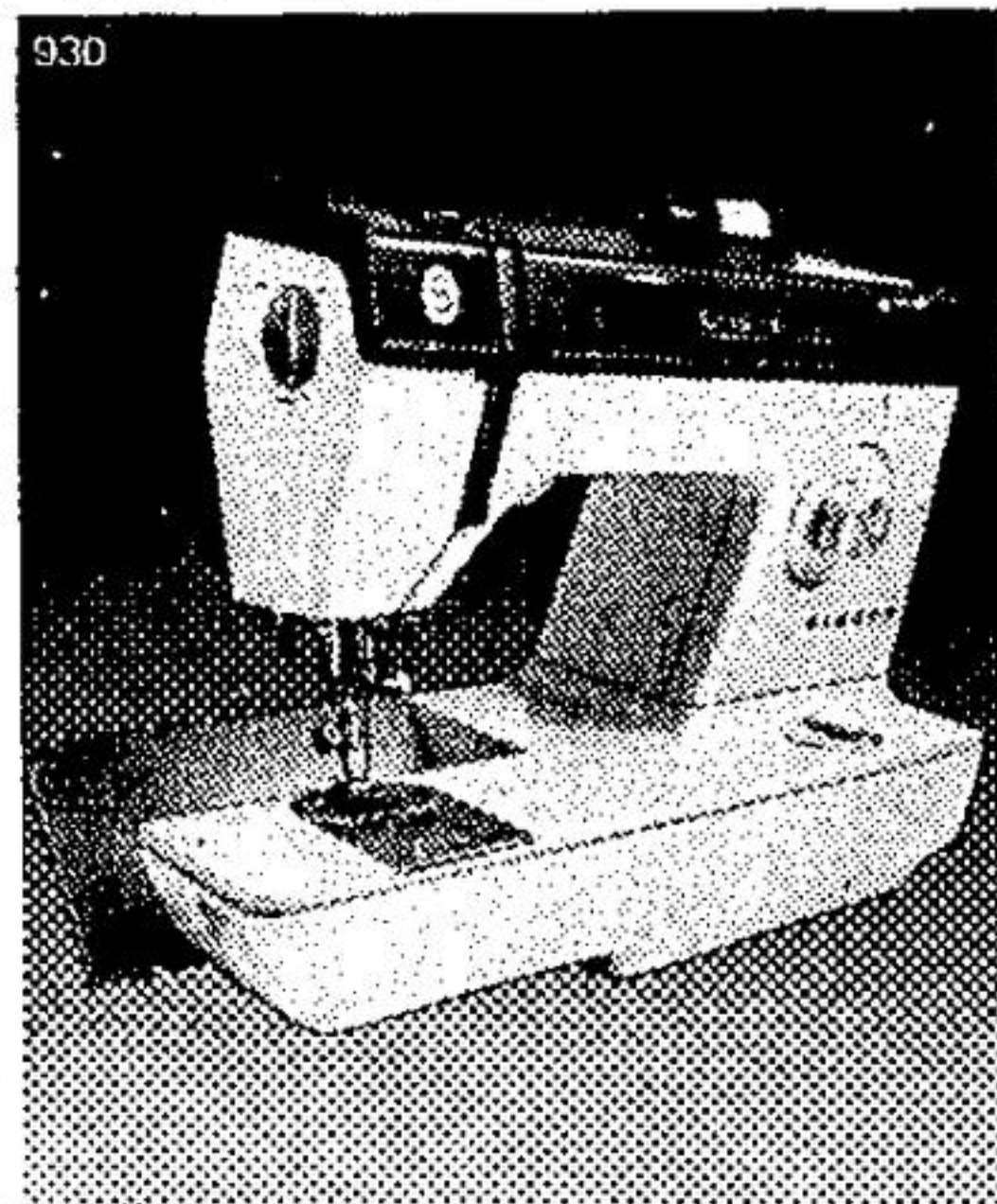

The Power-packed Canister Vacuum
Step right up to fast, deep-down cleaning at a smooth Singer price Model C-141

\$139

The Stylist* FREE ARM machine

Step right up for the greatest Singer sale! Featuring a lightweight, zig-zag machine with a host of special features:
• Built-in blind stitch
• Front drop-in bobbin
• Push-button reverse control. And it comes complete with base for flat bed sewing. Hurry, hurry... while this incredible offer lasts! Reg. Price: \$264.95 (Carrying case or cabinet extra.)

NOW ONLY \$229⁰⁰

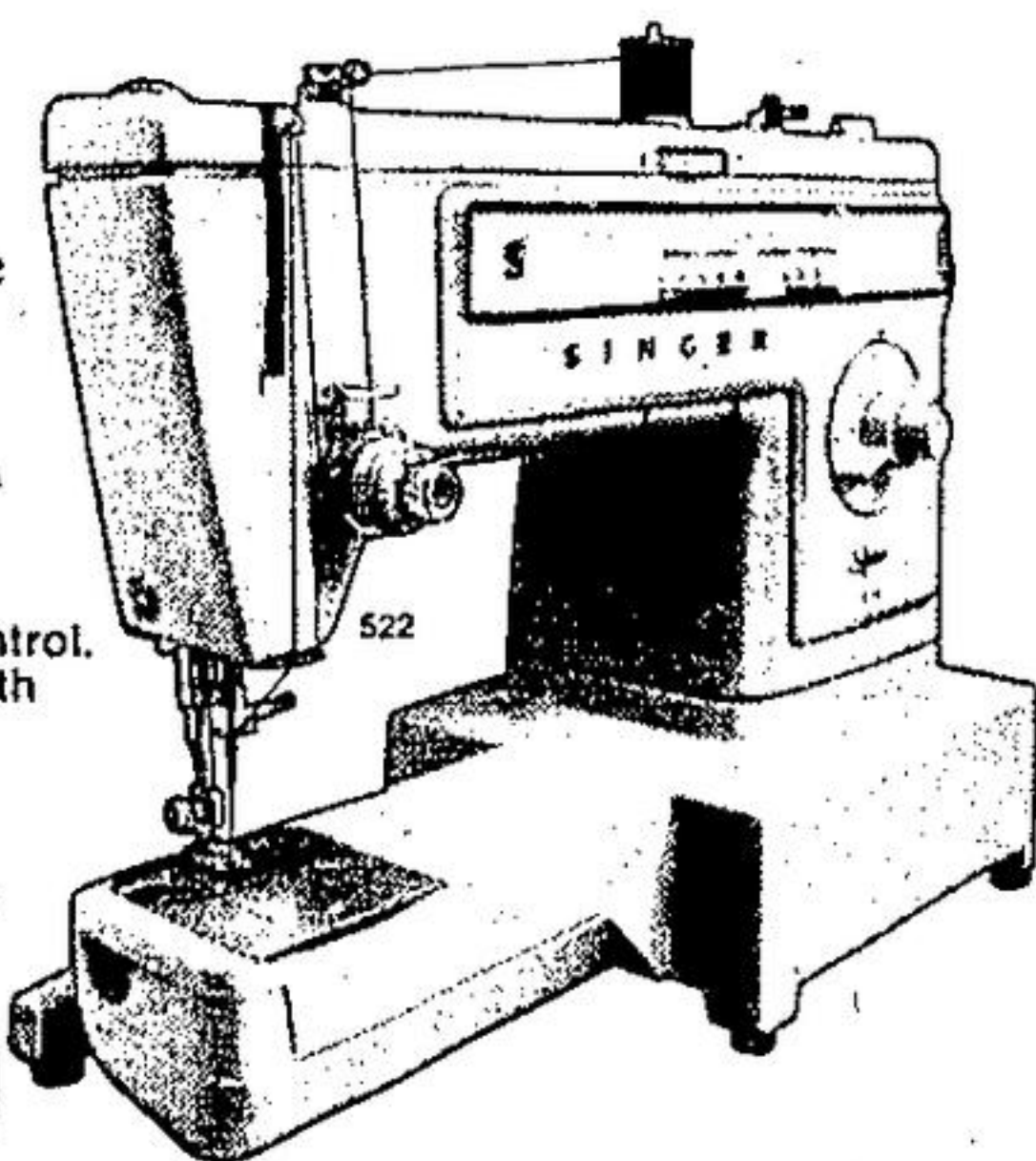

Cabinets and Carrying Case Extra unless otherwise stated

TRADE IN ALLOWANCE - CREDIT TERMS & MONTHLY PAYMENTS AVAILABLE

SINGER

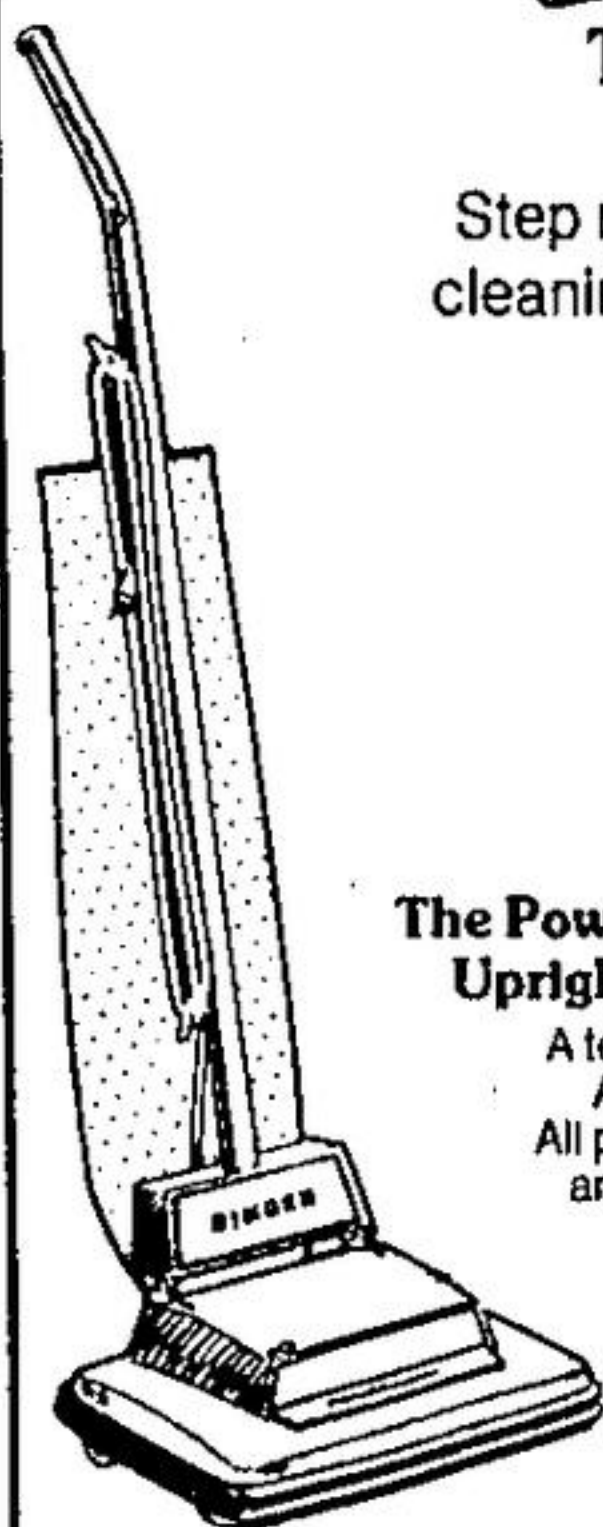

The Powermaster* Upright Vacuum
A terrific cleaner. A terrific price. All part of the one and only Singer Sale-A-Thon! Model U-60

\$109



stone road mall
821-0561

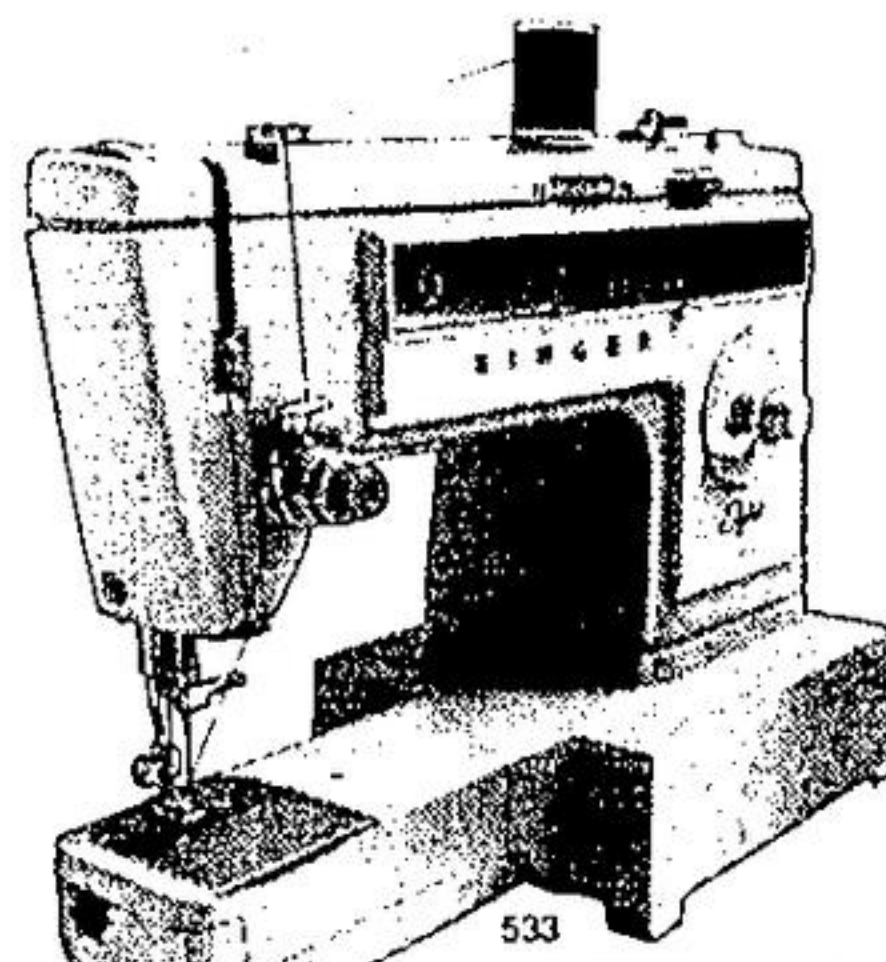
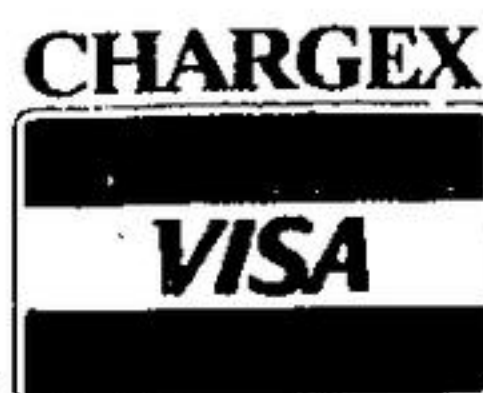

Singer FREE ARM stretch-stitch Stylist*

This versatile Singer machine has:
• built-in stretch, zig-zag and decorative stitches
• twin needle sewing
• easy conversion to flat bed sewing
• Singer quality, service and guarantee

NOW ONLY \$329⁰⁰
REG. \$364.95