

TWINDFALL SALE

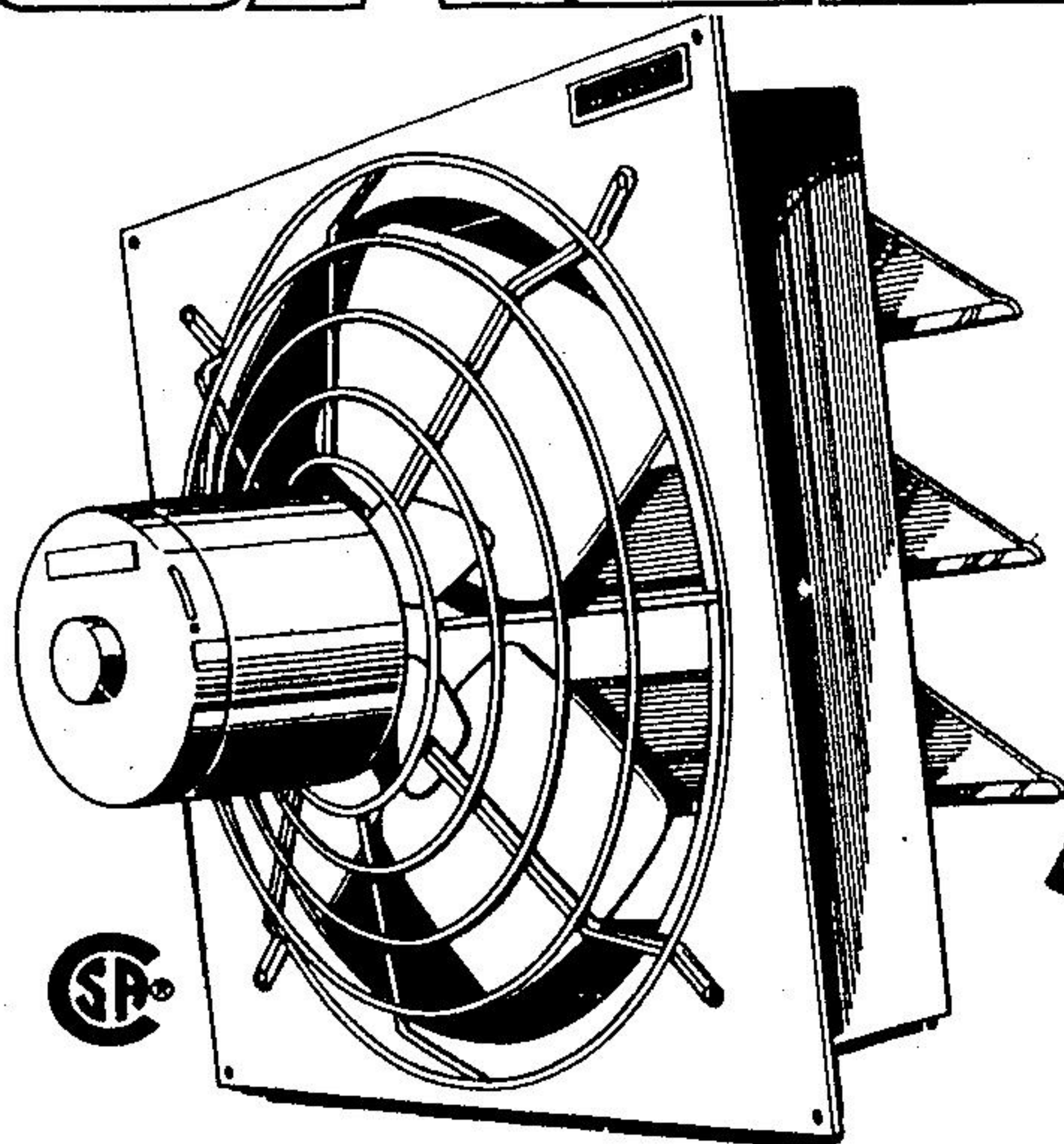

DIRECT-DRIVE 2-SPEED BARN FANS

for cattle, hog and poultry barn ventilation

- Steel welded housing box
- Balanced fan blades for less vibration and noise
- Totally enclosed motor with thermal overload protection
- Aluminum shutters angled-mounted for positive closing
 - Speed: High 1725 RPM, Low 850 RPM; 115 volt.

12" two speed fan: 1/4 HP motor. Framing size 15" x 15". 507-041
Farm Price Each \$99.89
12" two speed fan with control:
Farm Price Each \$134.88
18" two speed fan: 1/2 HP motor. Framing size 21" x 21". 507-039
Farm Price Each \$119.99
18" two speed fan with control.
Farm Price Each \$154.98

FARM PRICE: These Prices are special prices available only to those farmers qualified under the Federal Sales and Excise Tax Laws to purchase items used for agricultural purposes on tax and/or duty exempt basis. This must be supported by the filing of a valid end user certificate at the time of purchase.

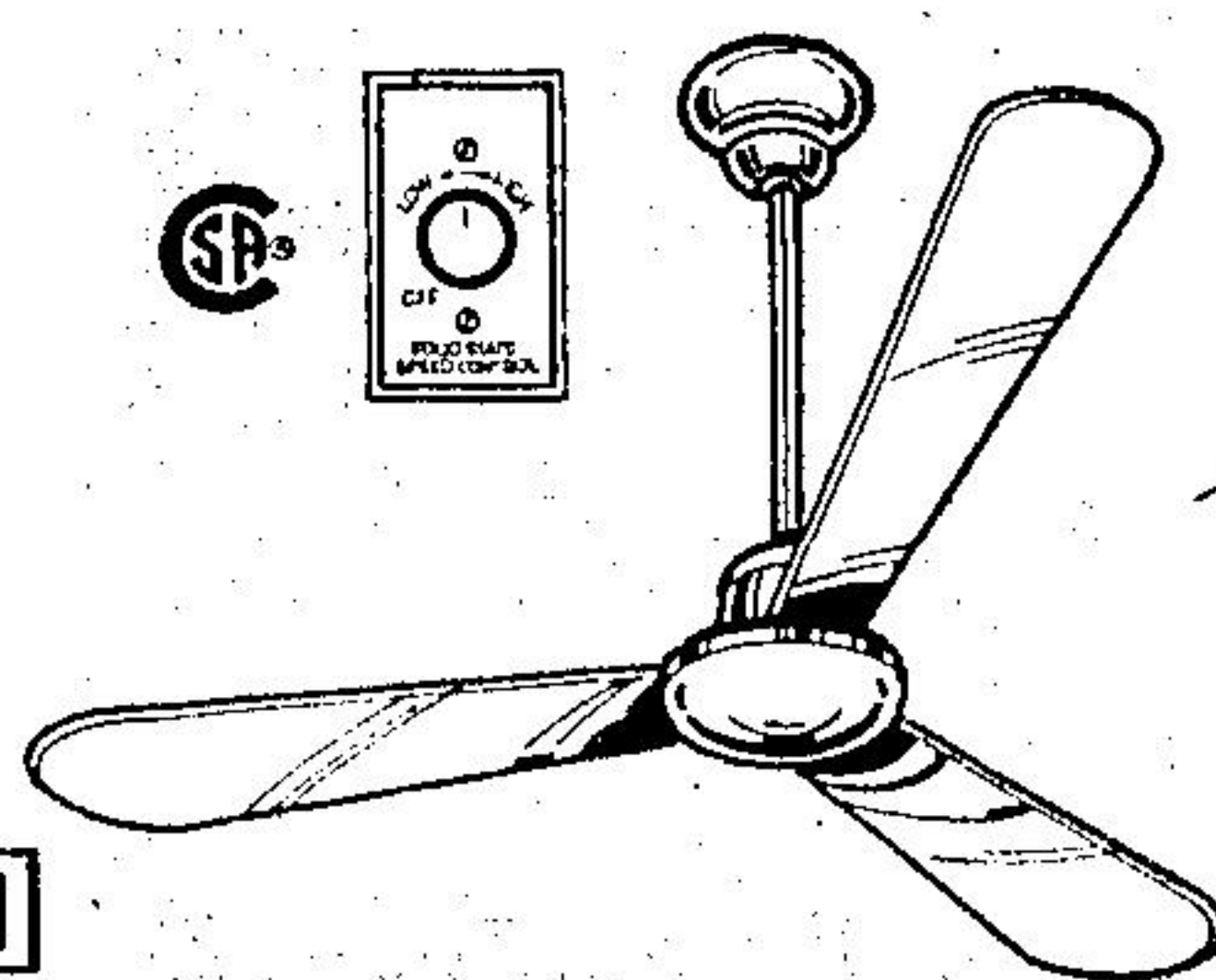

145⁹³
Farm Price ea.

CEILING RECIRCULATING FAN WITH CONTROL

56" ceiling recirculating fan with downdraft air flow; fan speed from 120 rpm to 280 rpm. 1500 sq. ft. coverage. Use it in your barn, arena or

greenhouse. Can help produce a heat saving in winter. Use fan on high speed for cooling in summer. 507-086 \$158.88

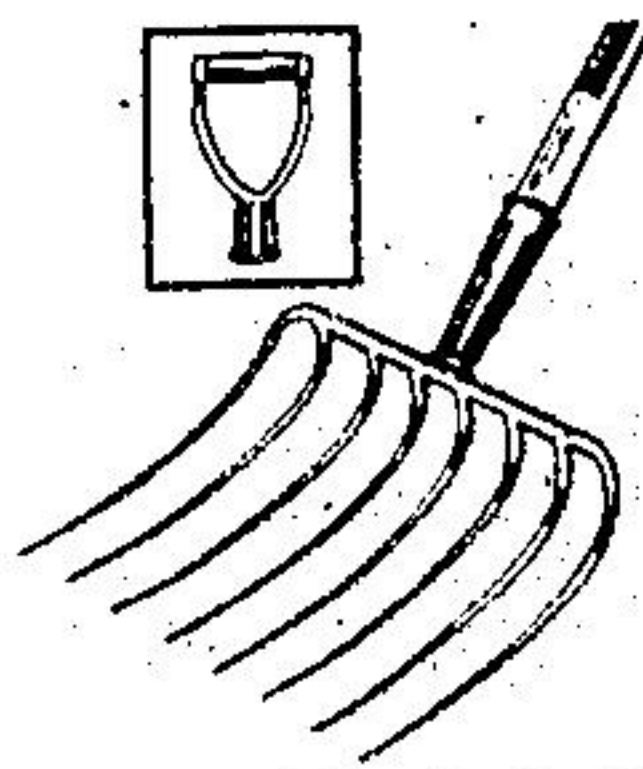

Chopped Hay Fork 29⁸⁸

For the big jobs! Has eight 19" long forged steel tines. Comfortable 'D' grip handle. 594-178

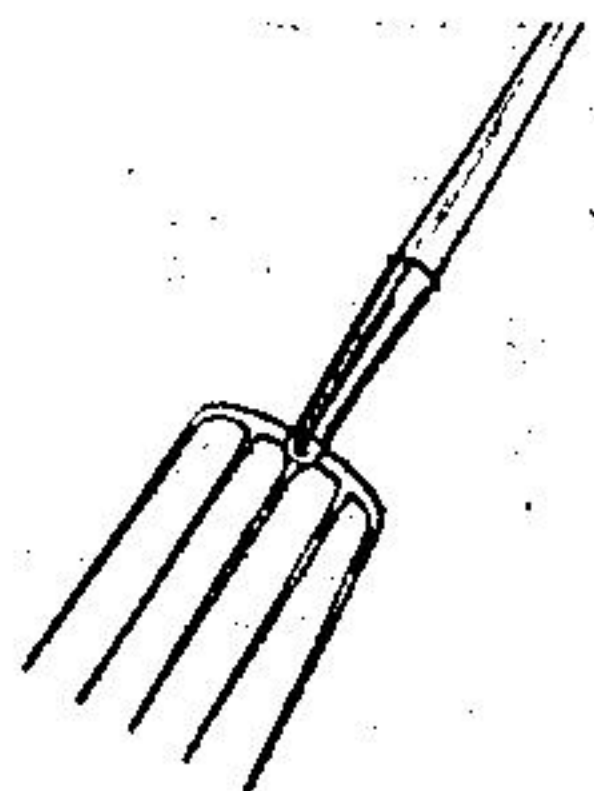

Long-handle Manure Fork 9⁸⁸

5-tine fork with smooth-polished and sharp-pointed forged steel oval tines. Ash handle. 590-047

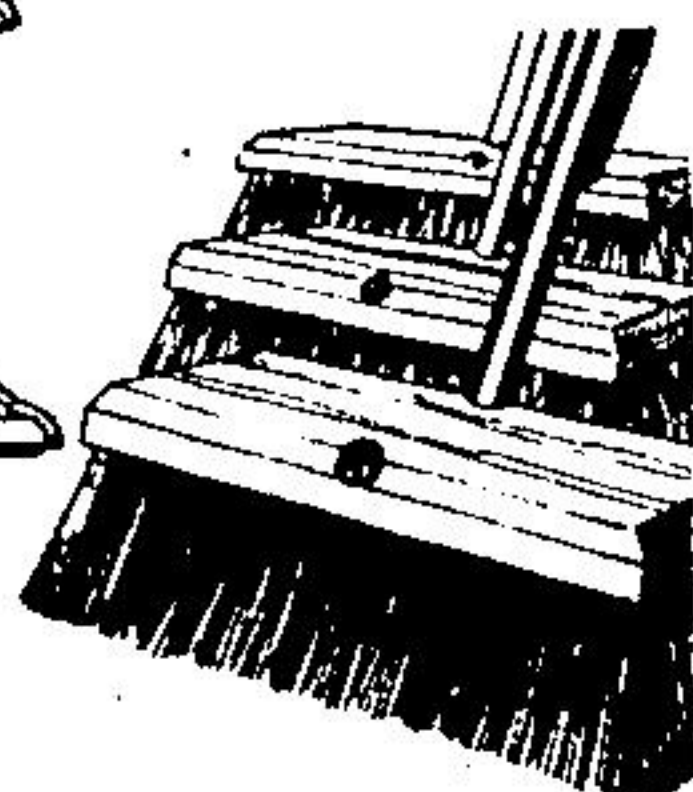

Stable Brooms with Handles 5⁹⁹

Heavy-duty nylon, fill, hardwood head predrilled on both sides. 14" . . . 551-306
16" . . . 551-308. . . \$8.19 ea.

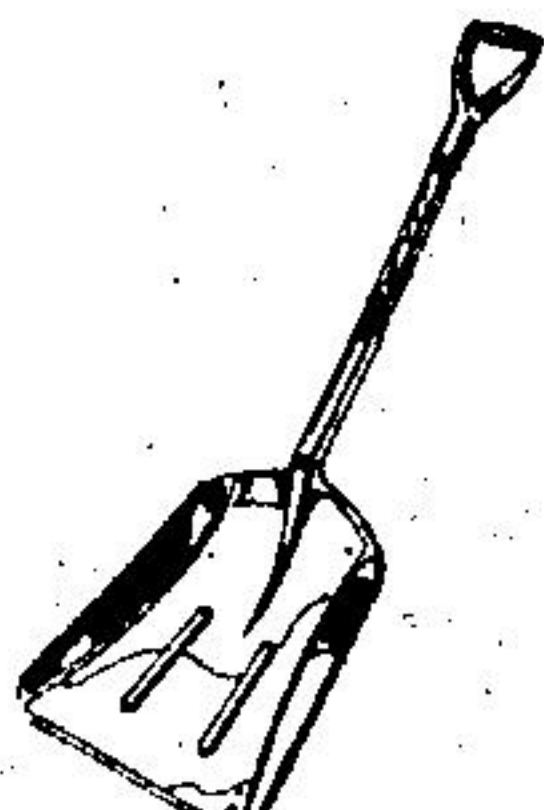

#8 Alum. Grain Scoop 9⁴⁴

Aluminum blade, ribbed for strength. Light, durable. Fire-hardened Ash handle. Y-D grip. 590-032

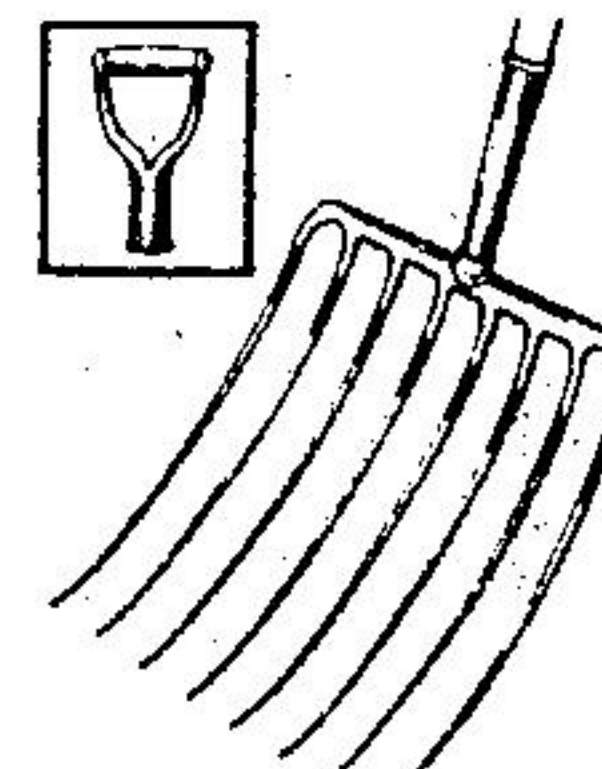

Ensilage Fork 18⁸⁸

Forged steel oval tines. Turned-up outside tines. 30" bent ash handle. Steel 'D' hand-grip. 590-052

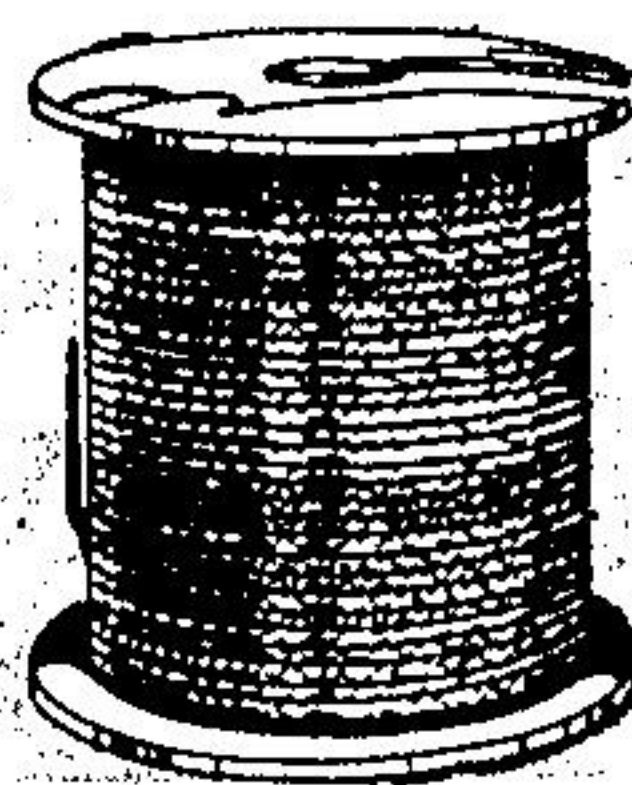

Galvanized Wire Rope

Fibre core for low flexibility, high resistance. Suitable for general purpose applications, guy lines.

1/4": 565-496 . . . Ea. ft. 23¢
250 ft. spool \$48.99
3/8": 565-495 . . . Ea. ft. 11¢
250 ft. spool 24.99



Tractor Tow Rope 23³³

1 1/4" x 20'. Light, easy-to-carry. Long-lasting polypropylene with two eye splices. Safe working load to 3240 lb. No backlash on break. 565-473
Farm price. 21.70